



***MAIN FRONT GATE MEGAPIXEL IP
VIDEO SURVEILLANCE SYSTEM***

Proposal For:

Attention: Gabriel Volante
Rainforest Estates Homeowners Association
4653 Saxon Road
Coconut Creek, FL 33073

Submitted By:

David Jacobson

June 25, 2019



June 25, 2019

Attention: Gabriel Volante
Rainforest Estates Homeowners Association
4653 Saxon Road
Coconut Creek, FL 33073

RE: Main Front Gate Megapixel IP Video Surveillance System

Dear Gabriel,

Per our meeting last week and walking the **Main Front Gate** with you the following is the **Proposal** for installing a **new Megapixel IP Video Surveillance System at this location**. The following Proposal contains the recommendations to address the specifications provided and the applications that were discussed, offering the latest types of technologies at the best possible price point. A list of what is covered by this Proposal is listed in the section entitled "Scope of Work".

I would like to tell you a little about our company.

Vector Security is listed as the 4th largest security company in the country by SDM Magazine and the second largest privately held company in the alarm industry. SDM Magazine also awarded Vector Security its prestigious "Dealer of the Year" Award for 2015, the only company to have been awarded this honor for the second time.

We now have 25 branch locations covering 11 states with more than 250,000 customers. Vector Security is a State Licensed, drug free, low voltage service provider specializing in commercial and residential security systems. Vector Security is "A+ RATED" by the Better Business Bureau at www.bbb.org. The Company operates 4 offices in Florida providing service from Jacksonville to Homestead and in the Florida panhandle.

Our company carries all required insurances and our employees are "FASA and BASA" licensed, a state law requirement for this industry. The company provides a full range of products and services from a basic residential security system to large commercial integrated systems with fire alarm, closed circuit television, security and access control.

Our Florida district has a fleet of more than 40 service and installation vehicles, and control every aspect of an installation, from the planning to the ongoing service of the system. Our 1200+ employees strive each day to distinguish themselves from the rest of the industry with superior service and customer care.



It is our goal to earn your business. At your convenience, please take the time to read more about Vector Security and our services at www.vectorsecurity.com. We are very proud of our accomplishments and feel that our commitment to delivering quality service to our customers has been the reason for our success.

If you have any questions or comments in regards to this Revision.1 Proposal, our services or if you would like to proceed with these Proposals please do not hesitate to give me a call.

Sincerely,

David Jacobson

dsjacobson@vectorsecurity.com

Cell: (954)636-0236



Scope of Work

MAIN FRONT GATE MEGAPIXEL IP VIDEO SURVEILLANCE SYSTEM

New Equipment:

- 1 Hikvision DS-2CD4A26FWD-IZHS/P 2-MP License Plate Recognition (LPR) Bullet Camera with up to 75ft. Capture Zone and a Capture Rate up to 99% for vehicles traveling up to 75MPH • 2.8-12mm lens (42°-13.5° field of view) • 1920 x 1080 Resolution • 1/1.8" Progressive Scan CMOS Sensor • Effective LED range 165 ft., 0 lux with IR ON, see in complete Darkness • True Wide Dynamic Range (WDR) • IP67 Weatherproof and IK10 Impact Rated UL Rated Enclosure
- 3 Hikvision DS-2CD2085G1-I 8-MP IP Megapixel Resolution Color/BW Outdoor Bullet Cameras with 2.8mm fixed-focal lens with a 102° field of view • 3840 x 2160 Resolution • ½" Progressive Scan CMOS Sensor • True Wide Dynamic Range (WDR) • DarkFigher Low-Light Technology • Effective LED range 100 ft., 0 lux with IR ON, See in complete darkness • IP67 Weatherproof and IK10 Impact UL Rated Enclosure
- 1 Hikvision DS-7608NI-I2/8P Network Video Recorder (NVR) with up to 8 IP PoE Inputs and 6-TB Hard-Drive • Remote monitoring, recording & playback simultaneously • Motion Detection Recording Mode included • 2 USB Ports • Fully Networkable • Remote viewing through free CMS Software and phone Applications • Approximately 12-15 weeks recording time
- 1 Hikvision iVMS-4200 Client Software for High Definition Network Management. Allows up to 51 users and up to 16 simultaneous tasks.
- 1 Hikvision Mobile Client Application which allows viewing of live and recorded video over a wireless network using Apple and Android phones and tablets from a single NVR
- 1 Meir Products BW136ACE NEMA-4 Environmental Wall Mounted Enclosure Cabinet with Built-in Air Conditioner Unit (36"H x 24"W X 12"D, located behind the front entry wall to house the NVR and monitor

(4) Total Main Front Gate Camera Locations Mounted on the Existing Light Pole as follows:

- One (1) 2MP IP LPR Bullet Camera mounted on the existing light pole located on the south side of the entrance gates to view the rear license plates on vehicles in the entry lane heading South before turning west.



Three (3) 8MP IP Bullet Cameras mounted on the existing light pole located on the west side of the entrance lanes to provide a detailed overview as follows:

- 1 – 8MP Camera providing an overview the entrance and exit lanes of Saxon Road by Lyons Road
- 1 – 8MP Camera providing an overview the entrance and exit lanes of Saxon Road and the swing gates
- 1 – 8MP Camera providing an overview the (2) lanes on Saxon Road as it bends North-South and then bends around the corner East West

Network Video Recorder (NVR):

Install One (1) 8-Channel (Camera) Linux-Embedded IP Network Video Recorder (NVR) with 6-TB Hard drive and Monitor installed in the included NEMA-4 Environmental Wall Mounted Enclosure located on the west rear side of the SE Entrance wall. Video can be viewed both live and recorded. Connect to client provided high speed internet connection. Connect NVR to free DDNS Dynamic IP Service to view the NVR over the Internet or from free smart phone applications.

INSTALLATION INVESTMENT: \$9,440.00*

EXTENDED SERVICE PROTECTION PLAN: \$55.95*
(Requires 3-year Agreement)

*Notes:

1. This price is good for 30 days from the below date.
2. Plus Sales Tax
3. Vector Security reserves the right to change equipment specifications to equal or better than stated.
4. All need underground conduits to be provided by others with pull strings per our specifications.
5. Needed 115VAC duplex electrical outlet to be provided by others at the Climate Controlled Enclosure.
6. Includes connecting the NVR to client provided Internet for remote viewing of the NVR. Client must provide network static IP connection or we can connected to a FREE DDNS IP connection, client must provide high-speed Internet connection for these services. Internet, and similar equipment, services and technical assistance are not included. Some of these can be provided on a time and material basis or by a 3rd party service provider.
7. Adequate lighting for the proper operation of the cameras is the client's responsibility.
8. Includes remote viewing software and system operation training.

MEGAPIXEL IP VIDEO SURVEILLANCE SYSTEM OPTIONS

- Option A: Upgrade the Hikvision DS-7608NI-I2 8-Channel (Camera) Network Video Recorder (NVR) with 6-TB Hard Drive to the following:
1. 8-Channels (Cameras) NVR with 8-TB Hard Drive: \$181.00* Add.
 2. 8-Channels (Cameras) NVR with 12-TB Hard Drive: \$576.00* Add.



Support Services

INSTALLATION

The installation of the equipment we have detailed is complemented with the following support services:

- Project management throughout the installation
- Submittal of permits, where applicable
- Field management of installation personnel
- User training – at system completion and ongoing as needed
- 24 x 7 x 365 service support

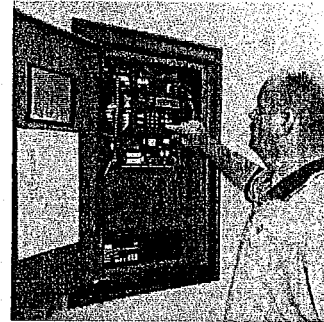

SERVICE AND SUPPORT

Following the installation, our relationship continues. In addition to our quality monitoring services, we have a highly skilled technical support department that will respond to your needs after installation. The Ft. Lauderdale Branch runs a fleet of operations vehicles to service area customers. Each technician underwent a background and motor vehicle record check. Annual drivers' record checks are conducted, as well as random and for cause substance screening. Technicians participate in regular training, both internal and from the manufacturers we support. We want only the most qualified and highly trusted individuals working in your business.

All your service requests and technician scheduling is handled out of our local Ft. Lauderdale office. This means that the individuals who are servicing and troubleshooting your account have access to your original installation records to reduce service time and improve service delivery. All service requests are tracked via our automated system. Standard service hours are Monday – Friday from 8 AM to 5 PM, but service is available at after-hours emergency rates 24 hours a day, 7 days a week. Technicians are available via pager and cell phone.



In order to eliminate confusion and guarantee prompt follow-up, all billing and customer service questions are also resolved at your local office. This team can make changes to billing cycles, accept payments, take changes to monitoring information or respond to any other questions you may have following installation.

VECTOR  **SECURITY.**

WHY VECTOR SECURITY?

VECTOR SECURITY'S UNIQUE HISTORY

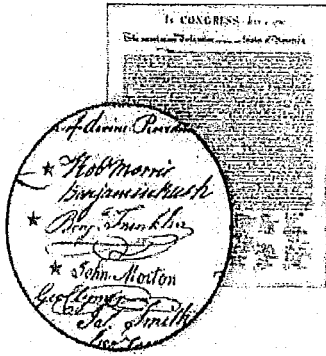

Vector Security, Inc., recognized as a national leader in the fire and security alarm industry, has been in business since 1970 and is the third largest provider of commercial alarm services. Vector Security is owned by The Philadelphia Contributionship, a private insurance company founded by Benjamin Franklin in 1752. Three of our founding directors – Benjamin Franklin, John Morton and Robert Morris – were signers of the Declaration of Independence. No other electronic security company shares our rich history of protection and dedication to the traditional values of service, innovation and genuine customer care first instituted by our corporate forefathers over 250 years ago.

FULL COMPLEMENT OF SERVICES AND PRODUCTS

Working with multiple vendors can be difficult and time consuming. It is our goal to be your single source for all of your security needs, and we provide a complete array of products and services to address those needs.

- Fire Alarm Installation, Maintenance and Monitoring
- Access Control Installation, Management and Maintenance
- CCTV / Video Installation, Maintenance and Monitoring
- Environmental Monitoring
- Solutions for Fire, Burglary, Access and Video Systems
- Radio and Cellular Back-ups to Standard Phone Line Connections

LOCAL PRESENCE AND INVOLVEMENT

Our office is located at 6555 N. Powerline Road, Suite 413, Ft. Lauderdale, FL 33309. Installation and service scheduling, as well as customer service and billing, are handled from this facility. We strongly believe that a local presence is important in being responsive to our customers and available if problems occur. When you select Vector Security you are not just selecting me, you are selecting a team of people that is dedicated to delivering excellent customer service.



Sample of Megapixel IP License Plate Recognition (LPR) Camera

Megapixel IP LPR cameras are engineered to capture license plates of moving vehicles in extreme light conditions, from ranges of up to 75' at up to 75mph.

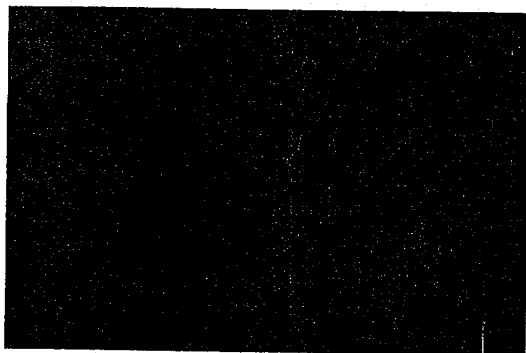

STANDARD NON – LPR CAMERA

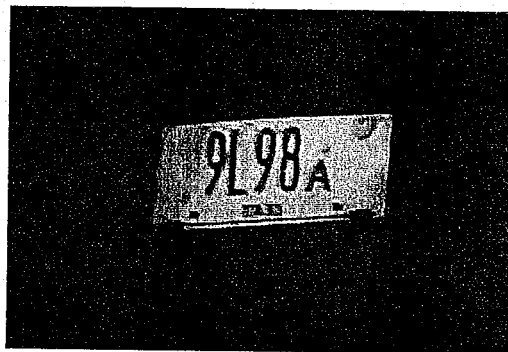

MEGAPIXEL LPR CAMERA

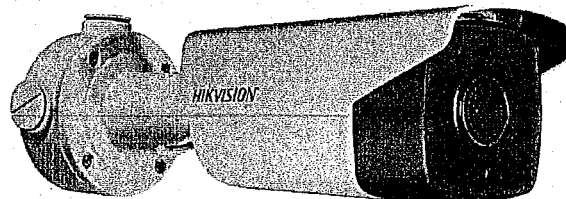

VECTOR  SECURITY.

Resolution Benefit

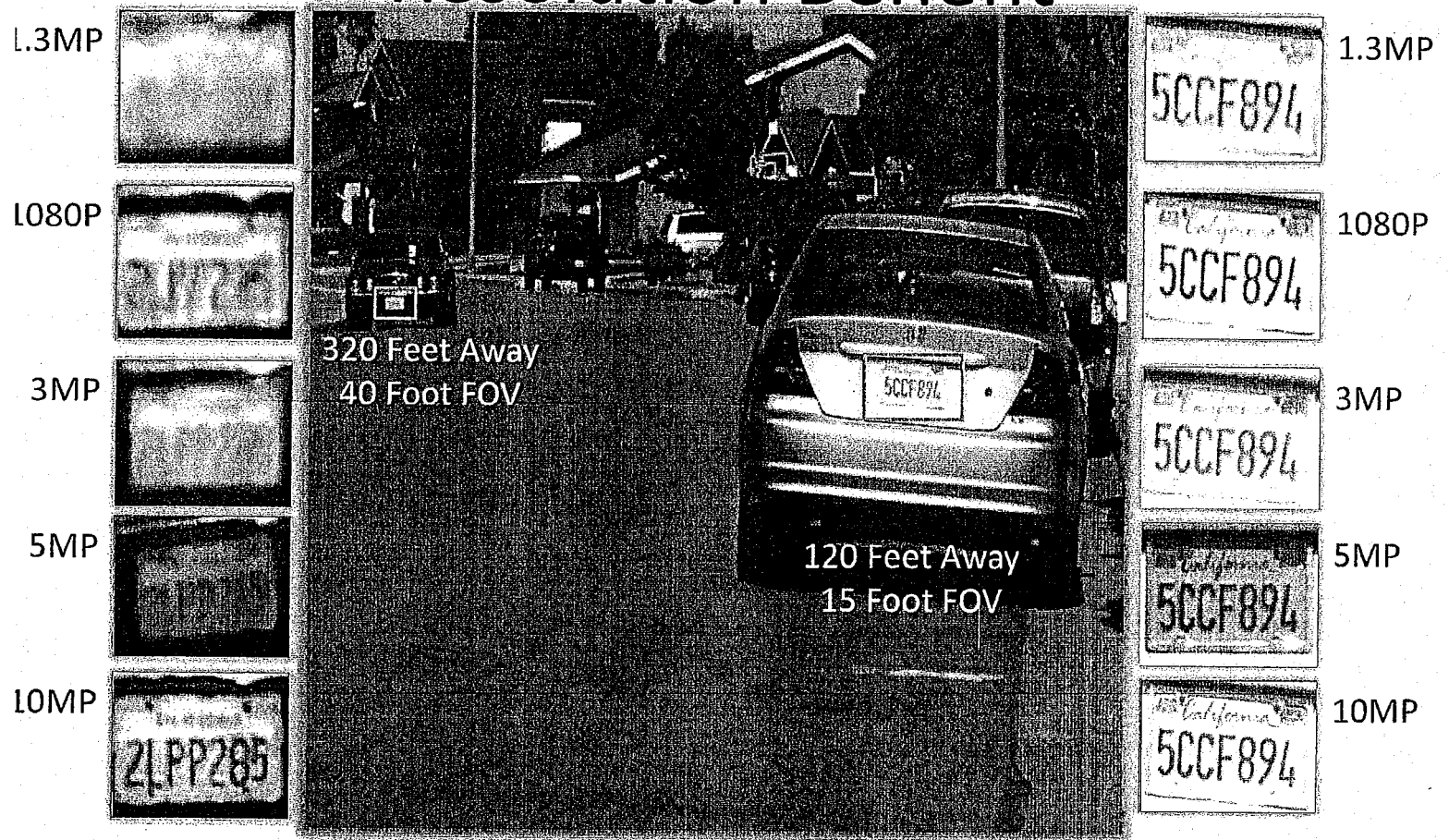



Mounting Examples for Mier Products' TEMPERATURE CONTROLLED ENCLOSURES

Mounted inside the gate-house at a gated community



Along a gate using metal tubing to run wiring from one enclosure to another

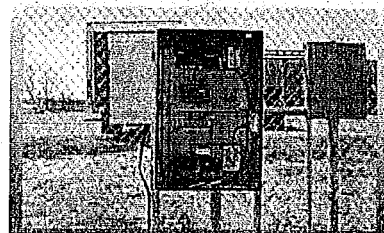

Wall-mount

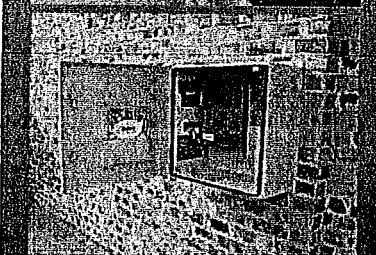

Rack Enclosure mounted on a wall



Using metal tubing or angle-iron and a concrete slab

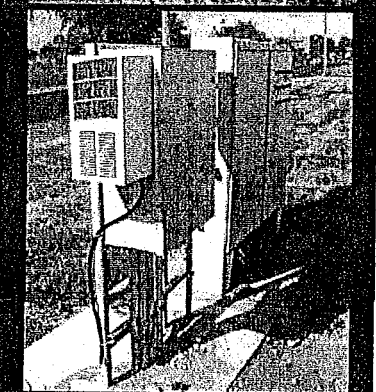

Installer made mounting surface

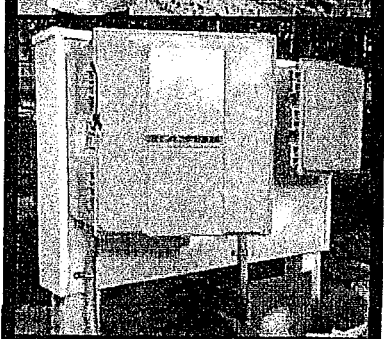

Using metal tubing and angle-iron

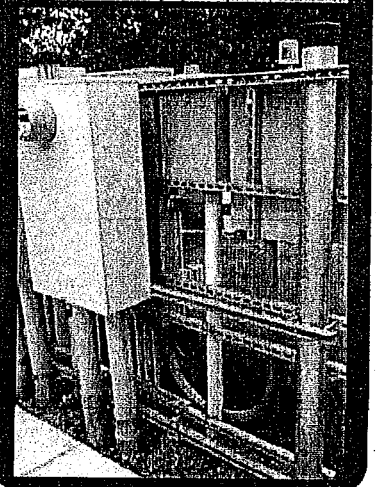

Pole-Mount Kits available for our enclosures to be mounted on 4" to 14" poles. Call us and specify the enclosure you want to use, and the pole size, for help choosing the correct pole-mount kit.

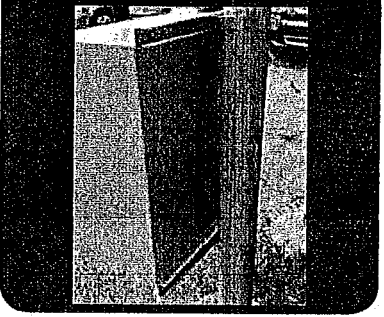

NOTE: Do Not Mount On Apartment/Condo/Office Walls
Home and office AC units are mounted a few feet away from a home or on the roof of an office building in order to avoid vibration noise from becoming a nuisance to those who live/work within. For that same reason, Mier recommends installers mount our temperature-controlled enclosures on concrete slabs with angle-iron or poles as pictured, or on walls that are not common to living or office space.

Our engineers recommend the following options around **RGS fittings** in holes installers might cut into the enclosures, in order to keep NEMA ratings: If not using conduit or flex-cable, and running your cords directly into the enclosure, we recommend drilling your holes in the bottom of the enclosure and using a Heyco fitting appropriate for your specific cord size, and able to fit in our 3/16" enclosure wall thickness. These fittings can be found at: http://www.heyco.com/Liquid_Tight_Cordgrips/index.cfm

- If you are using conduit or flex-cable, we recommend drilling your holes in the bottom of the enclosure and using an appropriate fitting such as:
- SealCon DS21AA-BK = 3/4" Liquid-Tight Conduit Fitting with DOUBLE Lock - <http://www.sealconusa.com/conduit/product/double-seal.html>
 - SealCon ST21NA-BK = 3/4" Liquid-Tight Conduit Fitting with SINGLE Lock - <http://www.sealconusa.com/conduit/product/condsttwist-npt.html>
 - McMaster Carr 7119K13 = 3/4" Liquid-Tight Conduit Fitting/Heavy-Duty - <http://www.mcmaster.com/#7119k13/=vg864m>



SPEC SHEET



LED HD PRO-GRADE COLOR MONITOR

0E-22LED



This professional grade widescreen LED 22" color monitor offers BNC, VGA & HDMI inputs. With an additional BNC looping output its versatility will allow it to work for any application. Boasting full HD 1920 x 1080p resolution this monitor will make your video come to life.

- 21.5" Diagonal Viewing Size
- 1920 X by 1080P Full HD Resolution
- BNC, VGA, HDMI Inputs
- Includes Audio, VGA, and HDMI Cables
- 2 Built-in Stereo Speakers

PART #: 0E-21LED
UPC: 811914021643
LENGTH: 20.34"
WIDTH: 2.02"
HEIGHT: 12.47"
WEIGHT: 5.73 LB.

Product Certification:



FOR MORE INFORMATION,
CONTACT YOUR ADI SALES PERSON.

wboxtech.com

DS-7600NI-I2/P Series Plug and Play Network Video Recorder

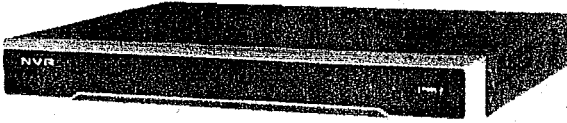

Key Features

- Up to 12 MP Resolution Recording
- Up to 16 IP Cameras Can Be Connected
- H.265/H.264+/H.264/MPEG4 Compression
- HDMI Video Output up to 4K (3840 × 2160)
- Plug and Play with up to 8 or 16 Independent PoE Network Connections
- 80 Mbps/160 Mbps Incoming Bandwidth
- Up to 2 SATA Interfaces
- Smart Search and Smart Playback
- Alarm and Audio I/O

Physical Interfaces

Description
1 AUDIO IN, RCA connector for audio input
2 AUDIO OUT, RCA connector for audio output
3 DB-15 connector for VGA output to display local video output and menu
4 HDMI video output connector
5 Controller port, alarm in/alarm out
6 LAN, 1 RJ-45 10/100/1000 Mbps self-adaptive Ethernet interface
7 USB 3.0 port
8 GND
9 100 to 240 VAC power supply
10 Power switch
11 Network interfaces with PoE function (8 interfaces for DS-7608NI-I2/8P and 16 interfaces for DS-7616NI-I2/16P)

	DS-7608NI-I2/8P	DS-7616NI-I2/16P
Video/Audio Input		
IP Video Input	8-ch Up to 12 MP resolution	16-ch
Two-Way Audio	1-ch, RCA (2.0 Vp-p, 1kΩ)	
Network		
Incoming Bandwidth	80 Mbps	160 Mbps
Outgoing Bandwidth	256 Mbps	
Remote Connection	128	
Video/Audio Output		
Recording Resolution	12 MP/8 MP/6 MP/5 MP/4 MP/3 MP/1080p/UXGA/720p/VGA/4CIF/DCIF/2CIF/CIF/QCIF	
HDMI Output Resolution	4K (3840 × 2160), 2K (2560 × 1440), 1920 × 1080p, 1600 × 1200, 1280 × 1024, 1280 × 720, 1024 × 768	
VGA Output Resolution	1920 × 1080p, 1280 × 1024, 1280 × 720, 1024 × 768	
Audio Output	1-ch, RCA (linear, 1 kΩ)	
Decoding		
Decoding Format	H.265/H.264/MPEG4	
Live View/Playback Resolution	12 MP/8 MP/6 MP/5 MP/4 MP/3 MP/1080p/UXGA/720p/VGA/4CIF/DCIF/2CIF/CIF/QCIF	
Synchronous Playback	8-ch	16-ch
Capability	2-ch @ 4K, or 8-ch @ 1080p	4-ch @ 4K, or 16-ch @ 1080p
Hard Disk		
SATA	2 SATA interfaces for 2HDDs	
Capacity	Up to 6 TB capacity for each HDD	
External Interface		
Network Interface	1 RJ-45 10/100/1000 Mbps self-adaptive Ethernet interface	
USB Interface	Front panel: 1 × USB 2.0; rear panel: 1 × USB 3.0	
Alarm In/Out	4/1	
Poe Interface		
Interface	8 RJ-45 10/100 Mbps self-adaptive Ethernet interfaces	16 RJ-45 10/100 Mbps self-adaptive Ethernet interfaces
Power	≤ 120 W	≤ 200 W
Supported Standards	IEEE 802.3 at/at	
General		
Power Supply	100 to 240 VAC, 50 to 60 Hz	
Power	≤ 180 W	≤ 280 W
Consumption (w/o HDD)	≤ 15 W (without enabling PoE)	
Working Temperature	-10 to +55° C (14 to 131° F)	
Working Humidity	10% to 90%	
Chassis	380 mm (15") chassis	
Dimensions (W × D × H)	380 mm × 290 mm × 45 mm (15.0" × 11.4" × 1.8")	
Weight (w/o HDD)	≤ 3 kg (6.6 lb)	

DS-7608NI-I2/8P

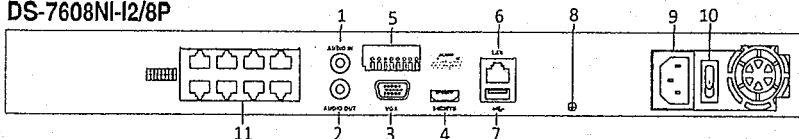

DS-7616NI-I2/16P

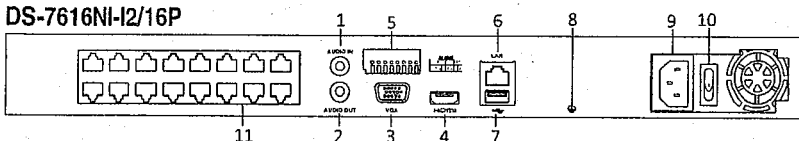

Order Model

- DS-7608NI-I2/8P
- DS-7616NI-I2/16P

Protect electronic equipment from vandals and weather

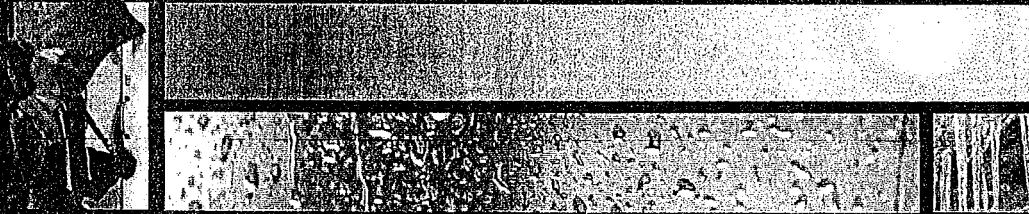

Temperature Controlled Enclosures

UL listed 2000 BTU AC Unit with internal 500W Heater. 115V, 60hz. Thermostat with variable control. Holes pre-cut for quick and easy mounting.

Removable door with a tubular lock and two 1/4-turn latches

Literature tray and key tabs

Removable back panel

Interior water channel and gasket

Tamper Switch

NEMA TYPE 4

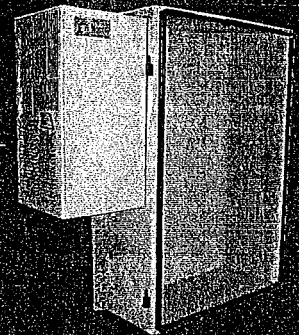

LISTINGS:
Enclosure:
NEMA Type 4 standards 250-1997 (1000V max.)
AC/Heater:
UL/CUL-SA6453, NEMA 4
Paint:
UL1332, NEMA 4
Gasket:
UL50, UL844, NEMA 4, FMVSS302
Tamper Switch:
UL Pending

STANDARD FEATURES ON ALL TEMPERATURE CONTROLLED MODELS:

NEMA Type 4 enclosure * 16 GA steel * outdoor gray paint * interior water channel and gasket * exterior mounting brackets * removable door with tubular lock and two 1/4-turn latches * literature tray with key tabs * tamper switch with mounting studs * ground stud

BW-124ACHT (center)
is 24" W x 24" H x 12" D

BW-136ACHT (above)
is 24" W x 36" H x 12" D

NOTE: To keep UL Listings and NEMA 4 Rating, installers must strictly follow OEM installation instructions and use water-tight fittings on all openings.

Mier
PRODUCTS, INC.

1-800-473-0213 | www.mierproducts.com

Wireless Vehicle Detection | Driveway Alarms | Drive-Up Window Detection | Buried Sensor Systems | Instrument Boxes
DVR/CPU Lockboxes | Flush-Mount Cabinets | Outdoor Enclosures | NEMA 4 Enclosures | Temperature Controlled Enclosures
Power Supply Boxes | Siren/Speaker Cabinets | Bell Boxes | Battery Cabinets | Transformer Enclosures | Custom Fabrication

Temperature Controlled and NEMA 4 Enclosures

Part Numbers and Descriptions

BW-124ACHT

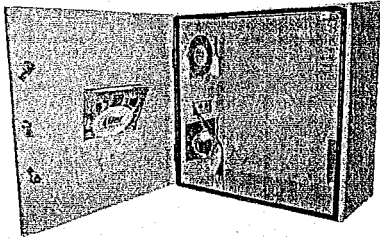

Shown with AC/Heater unit with thermostats attached, tamper switch, literature tray with key tags, 1/4-turn latches, and tubular lock

BW-124ACHT (temperature controlled enclosure)

- ◆ Outdoor NEMA Type 4 Enclosure
- ◆ 24"W x 24"H x 12"D
- ◆ Includes a removable 22"W x 22"H back panel with four standoffs
- ◆ Made of durable 16 gauge steel
- ◆ UL listed, NEMA Type 4 - **2000 BTU AC Unit** with built in **500 Watt Heater**. Both include thermostats with variable control.
- ◆ Holes, mounts, and gaskets pre-cut for mounting the AC/Heater unit
- ◆ Tamper Switch with NC and NO contacts and mounting studs
- ◆ Outdoor gray paint
- ◆ Interior water channel with a UL listed gasket for added protection
- ◆ Exterior mounting brackets with holes on top and on bottom
- ◆ Removable door with a tubular lock and two 1/4-turn latches
- ◆ Interior literature tray and key tabs
- ◆ Grounding stud

BW-136ACHT

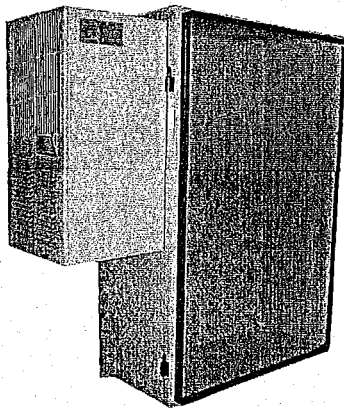

Shown with AC/Heater unit with thermostats attached, and door removed

BW-124BP (enclosure with back panel only)

- ◆ Outdoor NEMA Type 4 Enclosure
- ◆ 24"W x 24"H x 12"D with a removable 22"W x 22"H back panel

BW-136ACHT (temperature controlled enclosure)

- ◆ Same features as the BW-124ACHT (listed above), but taller
- ◆ 24"W x 36"H x 12"D with a removable 22"W x 34"H back panel

BW-136BP (enclosure with back panel only)

- ◆ Outdoor NEMA Type 4 Enclosure
- ◆ 24"W x 36"H x 12"D with a removable 22"W x 34"H back panel

Accessories:

- | | |
|--------------|---|
| BW-AC2000 - | 2000 BTU AC with a 500W Heater and thermostats (standard on ACHT units) |
| BW-TSW - | Plunger Tamper Switch with NC and NO contacts (standard on ACHT units) |
| BW-124PO - | 22" W x 22"H back panel
(Standard on BW-124 ACHT & BW-124BP units) |
| BW-136PO - | 22"W x 34"H back panel
(Standard on BW-136ACHT & BW-136BP units) |
| BW-50WHTR - | 50W/115V panel heater with thermostat
(not needed on ACHT models) |
| BW-250WHTR - | 250W/115V panel heater with thermostat
(not needed on ACHT models) |

Visit www.mierproducts.com to see more standard line outdoor and indoor enclosures

Mier
PRODUCTS, INC.

Wireless Vehicle Detection | Driveway Alarms | Drive-Up Window Detection | Buried Sensor Systems
Instrument Boxes | DVR/CPU Lockboxes | Flush-Mount Cabinets | Outdoor Enclosures | Temperature
Controlled Enclosures | Power Supply Boxes | Siren/Speaker Cabinets | Bell Boxes | Battery Cabinets
Transformer Enclosures | Custom Enclosures and Fabrication

www.mierproducts.com

VIDEO MANAGEMENT CLIENT SOFTWARE & HIKCONNECT

IVMS-4200 CLIENT SOFTWARE (WINDOWS AND MAC COMPATIBLE) – NO LICENSING FEE!

Live View	Support up to 4 output screens, recommend maximum of 32 live views
Encoding Device	Up to 256 encoded devices
Decoding Device	Up to 64 decoding devices
Imported Camera	Up to 1024 imported cameras
Camera Group	Up to 256 camera groups, with 64 maximum cameras in one group
Storage Server	Up to 16 storage servers, each server's recording performance is 64*2 Mbps
Stream Media Server	Up to 16 stream media servers, each server is with incoming connections of 64*2 Mbps and outgoing connections of 200*2 Mbps
Playback	16 channel playback. For best performance, 1 to 4 cameras at a time are recommended for remote playback
Download	Up to 16 simultaneous download tasks
User	Up to 51 users
System Log	Configurable, 1 to 6 months.
Map	Supports PNG, BMP, and JPEG images. Nested maps supported.
PTZ	Control, presets, patrols, patterns supported
Device Search	Supports Search Activated Device Protocol (SADP)
Device Configuration	Supports remote programming and configuration of any connected device. Features Add Device Wizard.
Minimum Server System Requirements	Windows 2003 / Windows 7 / Windows 8 / Windows 8.1 / Windows Server 2008 (32-bit or 64-bit), Windows Server 2008 R2 / Windows Server 2012 (64-bit)

IVMS-4500 MOBILE CLIENT APPLICATION FOR SMARTPHONES AND TABLETS

Mobile client software can be used to monitor the live video remotely from embedded hybrid DVR, NVR, DVR recorders, IP camera, IP speed dome or DVS/encoder via wireless network.

Number of Devices	100 device addresses
Live View	iPhone/Android Phone: 16 cameras
Remote Playback	iPhone/Android Phone/Windows Phone: 1-ch playback; iPad/Android Tablet: up to 4-ch
Configurable Image Quality	Clear, balanced, fluent, and customized
Frame Rate	Up to 25/30 fps (dependant on device and network)
Resolution	Up to 1080p
Stream Type	Video and audio
PTZ Control	Pan, tilt, zoom
Snapshot	Snapshot and video recording in Live View
Compatible Devices	Apple iOS (iPhone/iPad) ¹ Android (1.5 or higher) ² Windows Mobile ³

¹iPhone/iPad app must be acquired from the iTunes App Store.
²Android app can be obtained at the Android Market or www.hikvision.com
³Windows Phone 8 app must be acquired from the Windows Store.

HIKCONNECT P2P AND DDNS PLATFORM AND MOBILE APPS

HiKConnect is a remote access platform and mobile app that is designed to allow quick set up of your security cameras for remote viewing via the internet on a smart phone, tablet, desktop PC, or web browser.

Feature	HiKConnect P2P service	HiKConnect DDNS service
Require HiKConnect Account(s)	Yes	Yes
Port Forwarding* Required	No	Yes
Remote Configuration Permissions	1 Account	Multiple Accounts
Dual Authentication (HiKConnect and Device)	No	Yes
Maximum Continuous Live Viewing per Camera	5 min	Unlimited
Number of Simultaneous Playback Streams	1	4
Ability to Connect via Internet Explorer Web Browser	No	Yes

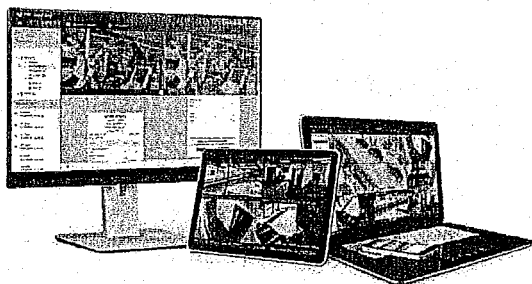

Standard Software is included in the compatible product packages only. No-fee policy applies to license, channel, software support agreement, and technical support access of Standard Software only. Customized software may incur additional fee. Apple, iPhone, iPad and iTunes are registered trademarks of Apple Inc. Android is a registered trademark of Google Inc. Windows Mobile is a registered trademark of Microsoft Corp. All other trademarks are property of their respective owners.

DS-2CD2085G1-I

8 MP Outdoor IR Fixed Network Bullet Camera

Powered by
DarkFighter.

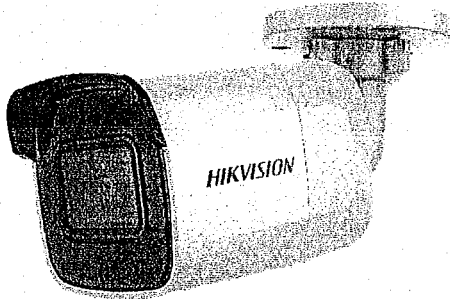

The Hikvision DS-2CD2085G1-I Outdoor IR Fixed Network Bullet Camera provides high definition output. It supports H.265+ video compression, which assures savings in bandwidth and storage.

The camera is equipped with 2.8 mm, 4 mm, and 6 mm lens options, and offers an EXIR 2.0 range of up to 165 ft (50 m).

Smart features, such as line crossing, intrusion, unattended luggage, and scene change detection are also supported.

- 1/2" (8 MP) Progressive Scan CMOS
- Up to 3840 x 2160 Resolution @ 20 fps
- Minimum Illumination:
Color: 0.016 lux @ (f/1.6, AGC on),
0 lux with IR
- Darkfighter Technology
- Up to 100 ft (30 m) EXIR 2.0 Range
- 2.8 mm, 4 mm, and 6 mm Lens Options
- H.265+, H.265, H.264+, H.264
- 120dB True WDR
- MicroSD Card Slot Supports 128 GB
- IP67, IK10 Protection
- 12 VDC and PoE (802.3af)

Available models:
DS-2CD2085G1-I



Specifications

DS-2CD2085G1-I

Camera

Image Sensor	1/2" progressive scan CMOS
Minimum Illumination	Color: 0.016 lux @ f/1.6, AGC on; 0 lux with IR
Shutter Speed	1/3 s to 1/100,000 s
Slow Shutter	Yes
Focal length	2.8 mm, 4 mm, 6 mm
Focus	Fixed
FOV	2.8 mm, horizontal FOV: 102°, vertical FOV: 55°, diagonal FOV: 120° 4 mm, horizontal FOV: 78°, vertical FOV: 43°, diagonal FOV: 92° 6 mm, horizontal FOV: 50°, vertical FOV: 27°, diagonal FOV: 59°
Lens Mount	M12
Iris	f/1.6
Day/Night	IR cut filter
DNR	3D DNR
Wide Dynamic Range	120dB
3-Axis Adjustment (Bracket)	Pan: 0° to 360°, tilt: 0° to 90°, rotate: 0° to 360°

Compression Standard

Video Compression	Main stream: H.265+/H.265/H.264+/H.264; sub stream: H.265+/H.265/H.264+/H.264/MJPEG; third stream: H.265+/H.265/H.264+/H.264
H.264 Type	Main profile/high profile
H.264+	Main stream supported
H.265 Type	Main profile
H.265+	Main stream supported
Video Bit Rate	32 Kbps to 16 Mbps

Image

Maximum Resolution	3840 × 2160
Main Stream	20 fps (3840 × 2160), 30fps (3072 × 1728, 2560 × 1440, 1920 × 1080, 1280 × 720)
Sub Stream	30 fps (640 × 480, 640 × 360, 320 × 240)
Third Stream	30 fps (1280 × 720, 640 × 360, 352 × 240)
Image Enhancement	BLC/3D DNR
Image Setting	Rotate mode, saturation, brightness, contrast, sharpness adjustable by client software or web browser
Region of Interest (ROI)	Supports one fixed region for main and sub streams
Day/Night Switch	Day/night/auto/schedule

Network

Network Storage	Supports microSD/SDHC/SDXC card (128G), local storage and NAS (NFS/SMB/CIFS), ANR
Alarm Trigger	Motion detection, tampering alarm, network disconnected, IP address conflict, illegal login, HDD full, HDD error
Protocols	TCP/IP, UDP, ICMP, HTTP, HTTPS, FTP, DHCP, DNS, DDNS, RTP, RTSP, RTCP, PPPoE, NTP, UPnP, SMTP, SNMP, IGMP, 802.1X, QoS, IPv6
Standard	ONVIF (PROFILE S, PROFILE G), ISAPI
General Function	One-key reset, anti-flicker, heartbeat, mirror, password protection, privacy mask, watermark, IP address filter
API	ONVIF (PROFILE S, PROFILE G), ISAPI
Simultaneous Live View	Up to six channels
User/Host	Up to 32 users, three levels: administrator, operator, and user
Client	iVMS-4200, Hik-Connect
Web Browser	IE8+, Chrome 31.0-44, Firefox 30.0-51, Safari 8.0+

Interface

Communication Interface	1-port RJ45 10M/100M self-adaptive Ethernet port
On-Board Storage	Built-in microSD/SDHC/SDXC slot, up to 128 GB
Reset Button	Yes
SVC	H.265 and H.264 encoding support

Smart Features

Behavior Analysis	Line crossing detection, intrusion detection, unattended baggage detection, object removal detection
Exception Detection	Scene change detection
Face Detection	Yes

General

Operating Conditions	-22° F to 140° F (-30° C to 60° C), humidity 95% or less (non-condensing)
Power Supply	12 VDC ± 25%, PoE (802.3af, class 3), 5.5 mm coaxial power plug
Power Consumption	12 VDC, 0.5 A, maximum: 6 W, PoE (802.3af, 36 VDC to 57 VDC), 0.2 A to 0.1 A, maximum: 7.5 W
IR Range	Up to 100 ft (30 m)
Wavelength	850 nm
Protection Level	IP67, IK10
Dimensions	2.8" × 2.7" × 6.7" (70 mm × 68 mm × 171)
Weight	1.50 lbs (0.70 kg)

Accessories

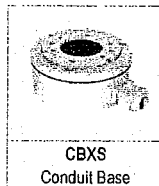

CBXS

Conduit Base

Dimensions

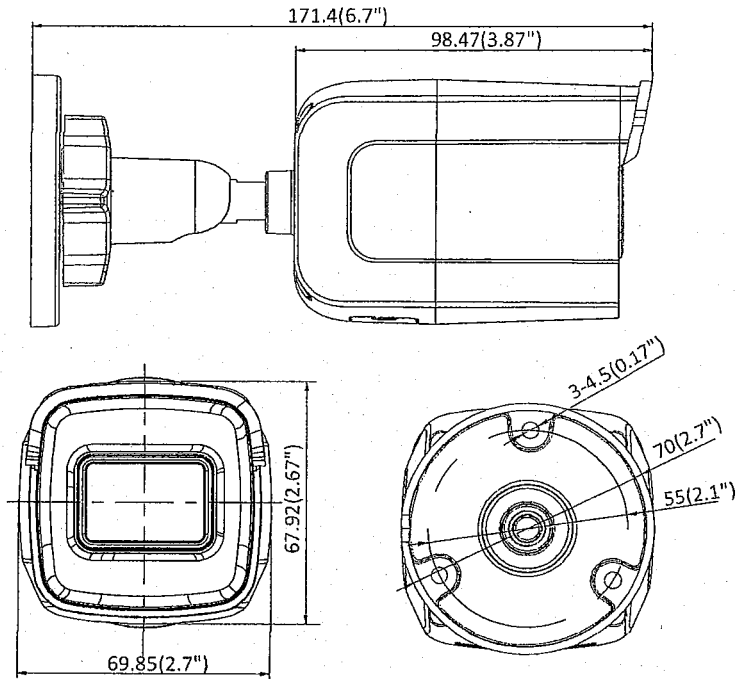

Unit: mm (inch)