

SECTION IV - REQUIRED DOCUMENTS**Proposal Requirements Checklist**

Proposer has completed the required documents listed in the checklist below. The required documents shall be executed, notarized (if applicable), and submitted as a condition to this Request for Proposals.

Proposer shall electronically submit all required documents and any other pertinent information electronically through the eBid System.

Required Documents	Yes	No
Proposer Information	<input checked="" type="checkbox"/>	<input type="checkbox"/>
Proposal Confirmation	<input checked="" type="checkbox"/>	<input type="checkbox"/>
Indemnification Clause	<input checked="" type="checkbox"/>	<input type="checkbox"/>
Non-Collusive Affidavit	<input checked="" type="checkbox"/>	<input type="checkbox"/>
Proposer's Qualification Statement & Acknowledgement	<input checked="" type="checkbox"/>	<input type="checkbox"/>
Non-Florida Corporation Form	<input checked="" type="checkbox"/>	<input type="checkbox"/>
References	<input checked="" type="checkbox"/>	<input type="checkbox"/>
Drug-Free Workplace Form	<input checked="" type="checkbox"/>	<input type="checkbox"/>
Sworn Statement on Public Entity Crimes	<input checked="" type="checkbox"/>	<input type="checkbox"/>
Exceptions to the RFP	<input checked="" type="checkbox"/>	<input type="checkbox"/>
Scrutinized Companies Form	<input checked="" type="checkbox"/>	<input type="checkbox"/>
Submitted Pricing through the eBid System "Line Items" Tab	<input checked="" type="checkbox"/>	<input type="checkbox"/>
Proposal Format: <ul style="list-style-type: none"> ➤ Proposed Portable Stage ➤ Proposal Price ➤ Qualifications and Experience ➤ References and Past Performance ➤ Design, Manufacturing and Delivery Time ➤ Value-Added Features / Services ➤ Overall Proposed Stage Solution 	<input checked="" type="checkbox"/>	<input type="checkbox"/>
Certificate of Insurance	<input checked="" type="checkbox"/>	<input type="checkbox"/>
Business Tax Receipt	<input checked="" type="checkbox"/>	<input type="checkbox"/>
Sunbiz	<input checked="" type="checkbox"/>	<input type="checkbox"/>

PROPOSER INFORMATION

Communications concerning this proposal shall be addressed to:



299 Prather Lane, PO Box C, Sellersburg, IN 47172 USA
Phone: 812/246-3371 Fax: 812/246-5446
www.centuryindustries.com

Company Name: _____

Social Security/Federal Tax I.D. No.: 35 2026536

Proposer's Name (Print): MICHELLE McRAE

Title: SALES MANAGER

Address: _____

City/State/Zip: _____

Phone: X12 Fax: _____

Email: michelle@centuryindustries.com

ACKNOWLEDGEMENT OF ADDENDA

Instructions: Complete Part I or Part II, Whichever Applies

Part I:

Proposer has examined copies of all the Contract Documents and of the following Addenda (receipt of all which is hereby acknowledged).

Addendum No: _____	Dated: _____
Addendum No: _____	Dated: _____
Addendum No: _____	Dated: _____
Addendum No: _____	Dated: _____
Addendum No: _____	Dated: _____

Part II:

No Addendum was received in connection with this RFP.

It is understood and agreed by Proposer that the City reserves the right to reject any and all proposals, to make awards on all items or any items according to the best interest of the City, and to waive any irregularities in the proposal or in the proposals received as a result of the RFP. It is also understood and agreed by the Proposer that by submitting a proposal, Proposer shall be deemed to understand and agree that no property interest or legal right of any kind shall be created at any point during the aforesaid evaluation/selection process until and unless a contract has been agreed to and signed by both parties.

Michelle McRae
Proposer's Authorized Signature

8/9/19
Date

MICHELLE McRAE
Proposer's Printed Name

PROPOSAL CONFIRMATION

In accordance with the requirements to provide a Portable Stage pursuant to RFP No. 08-14-19-11, the undersigned submits the attached proposal.

Proposer accepts and hereby incorporates by reference in this proposal all of the terms and conditions of the scope of work, including EPA Standards, Motor Vehicle Safety Standards and required warranty and guarantee certificates.

Proposer is fully aware of the scope of work based on these requirements, the legal requirements (federal, state, county and local laws, ordinances, rules and regulations) and the conditions affecting cost, progress or performance of the work and has made such independent investigation as Proposer deems necessary.

This proposal is genuine and not made in the interest of or on behalf of any undisclosed person, firm or corporation and is not submitted in conformity with any agreement or rules of any group, association, organization or corporation; Proposer has not directly or indirectly induced or solicited any other Proposer to submit a false or sham proposal; Proposer has not solicited or induced any person; firm or a corporation to refrain from proposing and Proposer has not sought by collusion to obtain for himself any advantage over any other Proposer or over City.

The Proposer shall acknowledge this Proposal by signing and completing the spaces provided. I hereby submit this Proposal Package for Portable Stage, RFP No. 08-14-19-11 to the City of Coconut Creek with the full understanding of the Request for Proposal, General Terms and Conditions, Special Terms and Conditions, Detailed Requirements, and the entire Proposal Package.

Michelle McKee
Proposer's Name

Michelle McKee
Signature

8/6/19
Date

State of: INDIANA

County of: CLARK

The foregoing instrument was acknowledged before me this 6 day of Aug, 2019,

by Michelle McKee, who is (who are) personally known to me or who

has produced DRIVER LIC. as identification and who did (did not) take an oath.

Christie R. Simmons
Notary Public Signature



Notary Name, Printed, Typed or Stamped

Commission Number: NP0719556

My Commission Expires: April 3, 2027

CITY OF COCONUT CREEK
PORTABLE STAGE
RFP NO. 08-14-19-11

SCHEDULE OF PROPOSAL PRICES

**PROPOSER SHALL SUBMIT PROPOSAL PRICE
ELECTRONICALLY THROUGH THE
EBID SYSTEM "LINE ITEMS" TAB**

WWW.COCONUTCREEK.NET/PURCHASING

PROPOSED PRICING

VISA Credit Card – Payment Method:

The City of Coconut Creek has implemented a Visa Procurement Card (P-Card) Program through SunTrust Bank. The City's preference is to pay for goods/services with the P-Card. This program allows the City to expedite payment to our vendors. Some of the benefits of the P-Card Program to the vendor are: payment received within 72 hours of receipt and acceptance of goods, reduced paperwork, issue receipts instead of generating invoices, resulting in fewer invoice problems, deal directly with the cardholder (in most cases).

Vendors accepting payment by the P-Card may not require the City (Cardholder) to pay a separate or additional convenience fee, surcharge or any part of any contemporaneous finance charge in connection with a transaction. Such charges are allowable, however must be included in the total cost of their response. Vendors are not to add notations such as "+3% service fee" in their response. All responses shall be inclusive of any and all fees associated with the acceptance of the P-Card.

Vendors agreeing to accept payment by P-Card must presently have the capability to accept Visa or take whatever steps necessary to implement the ability before the start of the agreement term.

Purchasing Card Acceptance



Why You Should Accept City of Coconut Creek's Purchasing Card

The Challenge

To optimize working capital, buying organizations are requesting that their suppliers accept purchasing cards for payment. By replacing their paper-based accounts payable process with an electronic purchasing card solution, buyers reduce their overall payables cost and suppliers reduce their collection expenses. As a supplier you will be able to accept credit card payments while minimizing your acceptance costs.

The Solution

We would like for you to begin accepting the SunTrust Purchasing Card. Payments made with a purchasing card provide faster receipt of funds, as they are deposited electronically to your checking account. We have partnered with SunTrust to negotiate preferred product and pricing solutions that fit the needs of Business-to-Business (B2B) purchasing card acceptance.

Here's How It Works

SunTrust will provide a computer-based solution that allows you to get the best effective rate for B2B card acceptance. A computer-based application is necessary to authorize and settle transactions at the best available interchange rate, as typical point-of-sale terminals do not have the capability to send the additional required enhanced data with the purchasing card transactions.

What's In It For You

With our B2B solution you will receive payments quicker than through the manual paper-based process. You can also:

- Achieve cost reductions in mail handling, depositing payments and collection
- Have your funds deposited electronically
- Receive payments faster and improved cash flow
- Gain greater visibility to manage cash flow through online reporting
- Increase accounting efficiency
- Receive competitive processing rates and fees
- Eliminate returned or lost checks processing and related expenses
- Experience reduced potential for fraud than with check payments
- Decrease days sales outstanding

City of Coconut Creek Preferred Supplier Acceptance Pricing

We have created a program to allow you to qualify at the best effective rates either by software or through a web-based solution.

Visa® Rate	Purchase Card Level 2	Purchase Card Level 3	Large Ticket Rate
*Interchange Rate	2.00% + \$0.05	1.80% + \$0.10	1.45% + \$35.00
*Assessment Fee	0.0925%	0.0925%	0.0925%
SunTrust Merchant Services Fee	0.20%	0.20%	0.20%
*Effective Rate	2.33%	2.13%	1.78%

*Rate provided by Visa

Purchase Level 2

To qualify for the Visa Level 2 Interchange Rates, the sales tax amount must be reported and the value must be greater than zero.

Purchase Level 3

To qualify for the Visa Level 3 Interchange Rate, Level 3 data (item description, product code, quantity, unit of measure and commodity code) must be reported. If the Sales tax is not applied, a value of zero (0.00) is required.

Purchase Large Ticket

To qualify for the Visa Large Ticket Interchange Rate, Level 2 and Level 3 data must be reported. Any transaction greater than \$6,980 that has the required data elements will qualify for the Visa Large Ticket Rate.

City of Coconut Creek Preferred Product Solution Pricing

Type	Solution Name	Price
Software-based Application	Payment Software	Set-up (one-time): Waived Monthly Access: \$0.00 Per Transaction:\$0.00
Internet-based Solution	Global Gateway e4	Set-up (one-time): Waived Monthly Access: \$9.95 Per Transaction:\$0.05

Value-Added Services

- Preferred Supplier status
- Set preferred processing fees for B2B acceptance
- No cost computer application
- No set-up fee
- No early termination fees
- Online reporting

Supplier Sign-Up:

To begin the supplier enrollment process, please call 855.468.0317.

INDEMNIFICATION CLAUSE
(Page 1 of 1)

The parties agree that one percent (1%) of the total compensation paid to Contractor for the work of the contract shall constitute specific consideration to Contractor for the indemnification to be provided under the Contract. The Contractor shall indemnify and hold harmless the City Commission, the City of Coconut Creek, and its agents and employees from and against all claims, damages, losses and expenses including attorney's fees arising out of or resulting from the performance of the work provided that any such claim, damage, loss or expense (1) is attributable to bodily injury, sickness, disease or death, or to injury to or destruction of tangible property (other than the work itself) including the loss of use resulting therefrom, and (2) is caused in whole or in part by any negligent act or omission of the Contractor, any subcontractor, anyone directly or indirectly employed by any of them or anyone for whose acts any of them may be liable, regardless of whether or not it is caused in part by a party indemnified hereunder.

In any and all claims against the City, or any of their agents or employees by any employee of the Contractor, any subcontractor, anyone directly or indirectly employed by any of them or anyone for whose acts any of them may be liable, the indemnification obligation under this Paragraph shall not be limited in any way by any limitation on this amount or type of damages compensation or benefits payable by or for the Contractor or any subcontractor under Workers' Compensation Acts, Disability Benefit Acts or other Employee Benefit Acts. Nothing in this section shall affect the immunities of the City pursuant to Chapter 768, Florida Statutes, as amended from time to time, nor shall it constitute an agreement by the City to indemnify Contractor, its officers, employers, subcontractors or agents against any claim or cause of action. This section shall not be construed as consent to be sued by any third parties in any matter arising out of this Agreement. The foregoing indemnification and release shall survive the termination of this Agreement.

Century Industries Mitchell McRae 8/16/19
Contractor's Name Signature Date

State of: Indiana
County of: Clark

The foregoing instrument was acknowledged before me this 6 day of Aug, 2019, by Mitchell McRae, who is (who are) personally known to me or who has produced Drivers Lic as identification and who did (did not) take an oath.

Christie R Simmons
Notary Public Signature

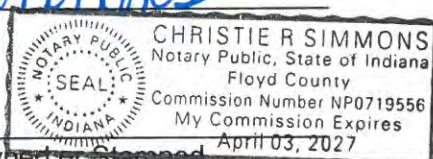

Notary Name, Printed, Typed or Stamped

Commission Number: NP0719556
My Commission Expires: April 3, 2027

NON-COLLUSIVE AFFIDAVIT

State of INDIANA)
 County of CLARK) ss.

MICHELLE McRAT being first duly sworn, deposes and says that:

- (1) He/she is the SALES MANAGER
 (Owner, Partner, Officer, Representative or Agent)
 of CENTURY INDUSTRIES the Proposer that has submitted the attached proposal;
- (2) He/she is fully informed respecting the preparation and contents of the attached proposal and of all pertinent circumstances respecting such proposal;
- (3) Such proposal is genuine and is not a collusive or sham proposal;
- (4) Neither the said Proposer nor any of its officers, partners, owners, agents, representatives, employees or parties in interest, including this affiant, have in any way colluded, conspired, connived or agreed, directly or indirectly, with any other Proposer, firm, or person to submit a collusive or sham proposal in connection with the work for which the attached proposal has been submitted; or to refrain from bidding in connection with such work; or have in any manner, directly or indirectly, sought by agreement or collusion, or communication, or conference with any Proposer, firm or person to fix the price or prices in the attached proposal of any other Proposer, or to fix an overhead, profit, or cost elements of the proposal price or the proposal price of any other Proposer, or to secure through any collusion, conspiracy, connivance, or unlawful agreement any advantage against (Recipient), or any person interested in the proposed work;
- (5) The price or prices quoted in the attached proposal are fair and proper and are not tainted by any collusion, conspiracy, connivance, or unlawful agreement on the part of the Proposer or any other of its agents, representatives, owners, employees or parties in interest, including this affiant.

Signed, sealed and delivered
in the presence of:

By: Michelle McBee
Michelle McBee
(Printed Name)

Sales Manager
(Title)

ACKNOWLEDGEMENT

State of INDIANA
County of CLATSOP

The foregoing instrument was acknowledged before me this 6 day of July,
20 19, by Michelle McBee, who is personally known to me or who has produced
Driver's Lic as identification and who did (did not) take an oath.

WITNESS my hand and official seal

Christie R Simmons
NOTARY PUBLIC

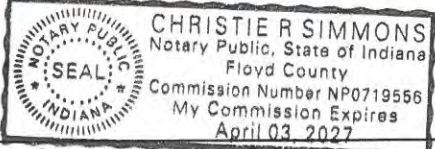

(Name of Notary Public: Print, Stamp, or
Type as Commissioned.)

PROPOSER'S QUALIFICATION STATEMENT

In order to properly evaluate the proposal submittals, Proposers are expected to complete the questionnaire and include the following documentation. By attesting to this submittal, Proposer guarantees the truth and accuracy of all statements and answers herein contained.

SUBMITTED TO: City of Coconut Creek
Purchasing and Contracts Division
4800 West Copans Road
Coconut Creek, FL 33063

Submitted By: MICHELLE McRAE
Name:
Address:
City, State, Zip
Telephone No.
Fax No.



299 Prather Lane, PO Box C, Sellersburg, IN 47172 USA
Phone: 812/246-3371 Fax: 812/246-5446
www.centuryindustries.com

Check One

- Corporation
Partnership
Individual
Other

1. State the true, exact, correct and complete name of the partnership, corporation, trade or fictitious name under which you do business and the address of the place of business.

The correct name of the Proposer is: MICHELLE McRAE

The address of the principal place of business is:



299 Prather Lane, PO Box C, Sellersburg, IN 47172 USA
Phone: 812/246-3371 Fax: 812/246-5446
www.centuryindustries.com

2. If Proposer is a corporation, answer the following:

- a. Date of Incorporation: 1997
b. State of Incorporation: Kentucky
c. President's Name: Bob UHL
d. Vice President's Name: JOHN UHL
e. Secretary's Name: JOHN UHL
f. Treasurer's Name: CHRISTY SIMMONS
g. Name and Address of Resident Agent: 299 Prather Lane, Sellersburg, IN.

3. If Proposer is an individual or a partnership, answer the following:

- a. Date of Organization: N/A
b. Name, Address and Ownership Units of all Partners:
c. State whether general or limited partnership:

4. If Proposer is other than an individual, corporation or partnership, describe the organization and give the name and address of principals:

N/A

5. If Proposer is operating under a fictitious name, submit evidence of compliance with the Florida Fictitious Name Statute.

6. How many years has your organization been in business under its present business name? 30 yrs

a. Under what other former name has your organization operated?

7. Indicate registration, license numbers or certificate numbers for the businesses or professions, which are the subject of this proposal. Please attach certificate of competency and/or state registration.

SEE ATTACHED (SUBBIZ REG.)

8. Litigation/Judgments/Settlements/Debarments/Suspensions:
Submit information on any pending litigation and any judgments and settlements of court cases relative to providing these services that have occurred within the last three (3) years. Also indicate if your firm has been debarred or suspended from bidding or proposing on a procurement project by any government during the last five (5) years.

ND

9. Have you ever failed to complete any work awarded to you? If so, state when, where and why?

ND

10. List the pertinent experience of the key individuals of your organization (continue on insert sheet, if necessary).

SEE REF.

11. State the name of the individual(s) and titles who will personally supervise the work:

James Ritchie - Production Manager

12. State the name and address of the attorney, if any, for the business of the Proposer:

13. State the names and addresses of all businesses and/or individuals who own an interest of more than five percent (5%) of the Proposer's business and indicate the percentage owned of each such business and/or individual:

Bob UHL - OWNER - 49%
JOHN UHL - VP - 48.5%
Greg Comfort - 2.5%

14. State the names, addresses and the type of business of all firms that are partially or wholly owned by Proposer:

NWB

15. State the name of Surety Company which will be providing the bond, and the name and address of agent:

N/A

16. List the following information concerning all Proposer's contracts in progress as of the date of submission and completed projects over the last five (5) years. (In case of any co-venture, list the information for all co-ventures.)

<u>Name of Project</u>	<u>Owner</u>	<u>Total Contract Value</u>	<u>Contracted Date of Completion</u>	<u>% of Completion to Date</u>
<u>M/S M 2800</u>	<u>N. Hempstead NY</u>	<u>(118,940)</u>	<u>2018</u>	<u>100%</u>
<u>M/S M 2800</u>	<u>Northfolk VA</u>	<u>(105,839)</u>	<u>2018</u>	<u>100%</u>
<u>M/S M 2800</u>	<u>Baltimore MD</u>	<u>(133,756)</u>	<u>2018</u>	<u>100%</u>

17. Have you personally inspected the site of the proposed work?

Yes No

18. Do you have a complete set of documents, including drawings and addenda, if applicable?

Yes No

19. Did you attend the pre-proposal conference if any such conference was held?

Yes No No Conference Held

20. Bank References:

Bank	Address/City/State/Zip	Telephone

The Proposer acknowledges and understands that the information contained in response to this Qualification Statement shall be relied upon by City in awarding the contract and such information is warranted by Proposer to be true. The discovery of any omission or misstatement that materially affects the Proposer's qualifications to perform under the contract shall cause the City to reject the proposal, and if after the award, to cancel and terminate the award and /or contract.

Proposer's Signature

Date 8/6/19

**ACKNOWLEDGEMENT
PROPOSER'S QUALIFICATION STATEMENT**

State of INDIANA

County of Clark

On this the 6 day of Aug, 2019, before me, the undersigned Notary Public of the State of Florida, Personally appeared

Michelle McKitt And
(Name(s) of individual(s) who appeared before notary)

whose name(s) is/are Subscribed to within the instrument, and he/she/they acknowledge that he/she/they executed it.

WITNESS my hand and official seal.

NOTARY PUBLIC

SEAL OF OFFICE:

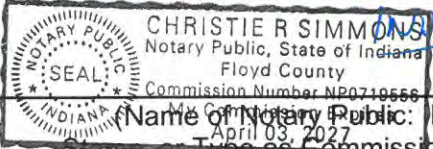
Christie R Simmons
NOTARY PUBLIC, STATE OF ~~FLORIDA~~ INDIANA

(Name of Notary Public: Print, Stamp, or Type as Commissioned)

- Personally known to me, or
- Produced identification

Printz Lic.
(Type of Identification Produced)

- DID take an oath, or
- DID NOT take an oath

FOREIGN (NON-FLORIDA) CORPORATIONS MUST COMPLETE THIS FORM

DEPARTMENT OF STATE CORPORATE CHARTER NO. Key w/ SUBBIZ (SEE ENCLOSED REG FORM)

If your corporation is exempt from the requirements of Section 607.1501, Florida Statutes as amended from time to time, **YOU MUST CHECK BELOW** the reason(s) for the exemption. Please contact the Department of State, Division of Corporations at (850) 245-6051 for assistance with corporate registration or exemptions.

607.1501 Authority of foreign corporation to transact business required.

- (1) A foreign corporation may not transact business in this state until it obtains a certificate of authority from the Department of State.
- (2) The following activities, among others, do not constitute transacting business within meaning of subsection (1):
 - (a) Maintaining, defending, or settling any proceeding.
 - (b) Holding meetings of the board of directors or shareholders or carrying on other activities concerning internal corporate affairs.
 - (c) Maintaining bank accounts.
 - (d) Maintaining officers or agencies for the transfer, exchange, and registration of the corporation's own securities or maintaining trustees or depositaries with respect to those securities.
 - (e) Selling through independent contractors.
 - (f) Soliciting or obtaining orders, whether by mail or through employees, agents, or otherwise, if the orders require acceptance outside this state before they become contracts.
 - (g) Creating or acquiring indebtedness, mortgages, and security interests in real or personal property.
 - (h) Securing or collecting debts or enforcing mortgages and security interests in property securing the debts.
 - (i) Transacting business in interstate commerce.
 - (j) Conducting an isolated transaction that is completed within 30 days and that is not one in the course of repeated transactions of a like nature.
 - (k) Owning and controlling a subsidiary corporation incorporated in or transacting business within this state or voting the stock of any corporation which it has lawfully acquired.
 - (l) Owning a limited partnership interest in a limited partnership that is doing business within this state, unless such limited partner manages or controls the partnership or exercises the powers and duties of a general partner.
 - (m) Owning, without more, real or personal property.
- (3) The list of activities in subsection (2) is not exhaustive.
- (4) This section has no application to the question of whether any foreign corporation is subject to service of process and suit in this state under any law of this state.

Please check one of the following if your firm is NOT a corporation:

- (I) Partnership, Joint Venture, Estate or Trust
- (II) Sole Proprietorship or Self-Employed

NOTE: This sheet **MUST** be enclosed with your bid if you claim an exemption above, your firm will be considered a corporation and subject to the requirements of this section.



299 Prather Lane, PO Box C, Sellersburg, IN 47172 USA
 Phone: 812/246-3371 Fax: 812/246-5446
 www.centuryindustries.com

Michael J. ...
 SIGNATURE OF AUTHORIZED AGENT OF BIDDER



[Department of State](#) / [Division of Corporations](#) / [Search Records](#) / [Detail By Document Number](#) /

Detail by Entity Name

Foreign Limited Liability Company
CENTURY INDUSTRIES, LLC

Filing Information

Document Number	M19000007340
FEI/EIN Number	35-2026536
Date Filed	07/31/2019
State	KY
Status	ACTIVE

Principal Address

299 PRATHER LANE
SELLERSBURG, IN 47172

Mailing Address

299 PRATHER LANE, PO BOX C
SELLERSBURG, IN 47172

Registered Agent Name & Address

CT CORPORATION SYSTEM
1200 SOUTH PINE ISLAND ROAD
PLANTATION, FL 33324

Authorized Person(s) Detail

Name & Address

Title MGR

UHL, BOB
299 PRATHER LANE, PO BOX C
SELLERSBURG, IN 47172

Title AP/SALES MANAGER

MCRAE, MICHELLE
299 PRATHER LANE, PO BOX C
SELLERSBURG, IN 47172

Title MGR

UHL, JOHN
299 PRATHER LANE, PO BOX C
SELLERSBURG, IN 47172

Title VP

UHL, JOHN
299 PRATHER LANE, PO BOX C
SELLERSBURG, IN 47172

Annual Reports

No Annual Reports Filed

Document Images

No images are available for this filing.

Florida Department of State, Division of Corporations

REFERENCES

The following is a list of at least four (4) references that Contractor has provided similar service in the past three (3) years. Government agency references are preferred.

1. Client Name: _____
Address: _____
City/State/Zip: _____
Contact: _____ Title: _____
Email Address: _____
Telephone: _____ Fax: _____
Scope of Work: _____
Contract Month/Year: _____ Contract Amount: \$ _____

2. Client Name: _____
Address: _____
City/State/Zip: _____
Contact: _____ Title: _____
Email Address: _____
Telephone: _____ Fax: _____
Scope of Work: _____
Contract Month/Year: _____ Contract Amount: \$ _____

3. Client Name: _____
Address: _____
City/State/Zip: _____
Contact: _____ Title: _____
Email Address: _____
Telephone: _____ Fax: _____
Scope of Work: _____
Contract Month/Year: _____ Contract Amount: \$ _____

NOTE: Additional references may be attached and provided.

SEE ATTACHED

18 REFERENCES ENCLOSED

References

<p>Miami Gardens City of; 0003148 18605 N.W. 27TH AVENUE Miami Gardens, FL 33056 (305)622-8000</p>	<p>Year: 2016 MSM2400</p>	<p>Miami Gardens City of; 0003149 1515 NW 167th St Ste 200 Miami Gardens, FL 33056 (305)622-8000</p>	<p>Year: 2016 MSM2400</p>
<p>Ocala City of; 0003186 828 NE 8 Ave. Ocala, FL 34470 (352)368-5517</p>	<p>Year: 2016 MSM3600</p>	<p>Pompano Beach Fleet Ops; 0003214 Pompano Beach, FL 33060 (954)786-4033</p>	<p>Year: 2016 MSM3600</p>
<p>Cooper City; 0003255 9000 SW 50th Place Cooper city, FL 33329 (954)434-4300</p>	<p>Year: 2017 MSM3200</p>	<p>Orlando City of; 0003283 1010 South Westmoreland Dr. Orlando, FL 32805 (407)246-3065</p>	<p>Year: 2018 MSM3200</p>
<p>Pembroke Pines; 0003288 10100 Pines Blvd. Bldg. (B) 2nd F Pembroke Pines, FL 33028 (954)435-6525</p>	<p>Year: 2018 MSM3600</p>	<p>Lakeland City of; 0003305 Lakeland, FL 33801 (863)413-2880</p>	<p>Year: 2018 MSM3200</p>
<p>NAS Key West; 0003354 Key West, FL 33040 (305)797-1813</p>	<p>Year: 2019 MSM2400</p>	<p>Snellville City of; 0002826 2342 Oak Road Snellville, GA 30078 (770)985-3517</p>	<p>Year: 2012 MSM2800</p>
<p>Ringgold City of; 0003036 150 Tennessee Street Ringgold, GA 30736 (706)935-3061</p>	<p>Year: 2014 MSM2400</p>	<p>Ramstein Air Base Germany; Mitchell Heben 86 FSS/F SRBldg. 2128 APO AE, Germany 09094-3221 0631-47-6020</p>	<p>Year: 2017 MSM3600</p>
<p>Naval Station Pearl Harbor; 0003116 CSSO CENTRAL WAREHOUSE Honolulu, HI 96818 (808)306-8830</p>	<p>Year: 2015 MSM3600</p>	<p>Normal Town of; 0003144 11 Uptown Circle Normal, IL 61761 (309)454-9540</p>	<p>Year: 2016 MSM2400</p>
<p>Cass County Community Foundation; 0002894 1212 Riverside Dr. Logansport, IN 46947 (574)753-6969</p>	<p>Year: 2013 MSM3600</p>	<p>Shelby County Plan Commission; 0003118 25 West Polk Street, Room 201 Shelbyville, IN 46176 (317)512-4306</p>	<p>Year: 2015 MSM3200</p>
<p>North Vernon City of; 0003188 Clerk-Treasurer 143 East Walnut North Vernon, IN 47265 (812)346-5907</p>	<p>Year: 2016 MSM3600</p>	<p>Franklin City of; 0003213 396 Branigin Blvd Franklin, IN 46131 (317)736-3689</p>	<p>Year: 2016 MSM3600</p>

DRUG-FREE WORKPLACE FORM

The undersigned vendor in accordance with Section 287.087, Florida Statutes as may be amended from time to time, hereby certifies that Century Industries does:
(Name of Business)

- 1) Publish a statement notifying employees that the unlawful manufacture, distribution, dispensing, possession, or use of a controlled substance is prohibited in the workplace and specifying the actions that will be taken against employees for violations of such prohibition.
- 2) Inform employees about the dangers of drug abuse in the workplace, the business's policy of maintaining a drug-free workplace, any available drug counseling, rehabilitation, and employee assistance programs, and the penalties that may be imposed upon employees for drug abuse violations.
- 3) Give each employee engaged in providing the commodities or contractual services that are under bid a copy of the statement specified in subsection (1).
- 4) In the statement specified in subsection (1), notify the employees that, as a condition of working on the commodities or contractual services that are under bid, the employee will abide by the terms of the statement and will notify the employer of any conviction of, or plea of guilty or nolo contendere to, any violation of *Florida Statutes*, Chapter 893 or of any controlled substance law of the United States or any state, for a violation occurring in the workplace no later than five (5) days after such conviction.
- 5) Impose a sanction on, or require the satisfactory participation in a drug abuse assistance or rehabilitation program if such is available in the employee's community, by any employee who is so convicted.
- 6) Make a good faith effort to continue to maintain a drug-free workplace through implementation of this section.

As the person authorized to sign the statement, I certify that this firm complies fully with the above requirements.



Proposer's Signature

Century Industries

299 Prather Lane, PO Box C, Sellersburg, IN 47172 USA
 Phone: 812/246-3371 Fax: 812/246-5446
www.centuryindustries.com

Date

8/6/19

**SWORN STATEMENT
ON PUBLIC ENTITY CRIMES
UNDER FLORIDA STATUTES CHAPTER 287.133(3)(a).**

THIS FORM MUST BE SIGNED IN THE PRESENCE OF A NOTARY PUBLIC OR OTHER OFFICER AUTHORIZED TO ADMINISTER OATHS.

1. This sworn statement is submitted with RFP No. 08-14-19-11 for Portable Stage.
2. This sworn statement is submitted by CENTURY INDUSTRIES (name of entity submitting sworn statement) whose business address is 299 Feather Lane and (if applicable) its Federal Employer Identification Number (FEIN) is 352026536. (If the entity has no FEIN, include the Social Security Number of the individual signing this sworn statement: _____.)
3. My name is Michelle McKee and my (Please print name of individual signing) relationship to the entity named above is Sales Manager.
4. I understand that a "public entity crime" as defined in Paragraph 287.133(1)(g), Florida Statutes, means a violation of any state or federal law by a person with respect to and directly related to the transaction of business with any public entity or with an agency or political subdivision of any other state or with the United States, including, but not limited to, any bid or contract for goods or services to be provided to any public entity or an agency or political subdivision of any other state or of the United States and involving antitrust, fraud, theft, bribery, collusion, racketeering, conspiracy, or material misrepresentation.
5. I understand that a "convicted" or "conviction" as defined in Paragraph 287.133(1)(b), Florida Statutes, means a finding of guilt or a conviction of a public entity crime, with or without an adjudication of guilt, in any federal or state trial court of record relating to charges brought by indictment or information after July 1, 1989, as a result of a jury verdict, nonjury trial, or entry of a plea of guilty or nolo contendere.
6. I understand that an "affiliate" as defined in Paragraph 287.133(1)(a), Florida Statutes, includes but is not limited to:
 1. A predecessor or successor of a person convicted of a public entity crime: or
 2. An entity under the control of any natural person who is active in the management of the entity and who has been convicted of a public entity crime. The term "affiliate" includes those officers, directors, executives, partners, shareholders, employees, members, and agents who are active in the management of an affiliate. The Ownership by one person of shares constituting a controlling interest in another person, or a pooling of equipment or income among persons when not for fair market value under an arm's length agreement, shall be a prima facie case that one person controls another person. A person who knowingly enters into a joint venture with a person who has been convicted of a public entity crime in Florida during the preceding thirty-six (36) months shall be considered an affiliate.
7. I understand that a "person" as defined in Paragraph 287.133(1)(e), Florida Statutes, means any natural person or entity organized under the laws of any state or of the United States with the

legal power to enter into a binding contract and which bids or applies to bid on contracts for the provision of goods or services let by a public entity, or which otherwise transacts or applies to transact business with a public entity. The term "person" includes those officers, who are active, or who have been active, directors, executives, partners, shareholders, employees, members, and agents who are active in management of an entity within the last five (5) years of this sworn statement.

8. Based on information and belief, the statement which I have marked below is true in relation to the entity submitting this sworn statement. **Please check all statements that are applicable.**

- Neither the entity submitting this sworn statement, nor any officers, directors, executives, partners, shareholders, employees, members, or agents who are active in management of the entity, nor any affiliate of the entity have been charged with and convicted of a public entity crime subsequent to July 1, 1989.
- The entity submitting this sworn statement, or one or more of the officers, directors, executives, partners, shareholders, employees, members, or agents who are active in management of the entity, or an affiliate of the entity has been charged with and convicted of a public entity crime subsequent to July 1, 1989, AND (Please indicate which additional statement applies.)
- There has been a proceeding concerning the conviction before a hearing officer of the State of Florida, Division of Administrative Hearings. The final order entered by the hearing officer did not place the person or affiliate on the convicted vendor list. (Please attach a copy of the final order.)
- The person or affiliate was placed on the convicted vendor list. There has been a subsequent proceeding before a hearing officer of the State of Florida, Division of Administrative Hearings. The final order entered by the hearing officer determined that it was in the public interest to remove the person or affiliate from the convicted vendor list. (Please attach a copy of the final order.)

9. Based on information and belief, the statement that I have marked below is true in relation to the entity submitting this sworn statement. **Please check if statement is applicable.**

- The person or affiliate has not been placed on the convicted vendor list.
(If the box is not checked, please describe any action taken by or pending with the Department of General Services.)

10. The herein sworn statement shall be subject to and incorporate all the terms and conditions contained in Section 287.133 of the Florida Statutes.

11. Conviction of a public entity crime shall be cause for disqualification.

Century Industries

299 Prather Lane, PO Box C, Sellersburg, IN 47172 USA
Phone: 812/246-3371 Fax: 812/246-5446
www.centuryindustries.com

Michelle McCal
Signature

Date: 8/6/19

State of: INDIANA

County of: Clark

The foregoing instrument was acknowledged before me this 6 day of Aug,
20 19, by Michelle McCal, who is (who are) personally known to me or who has
produced Drivers Lic as identification and who did (did not) take an oath.

Christie R Simmons
Notary Public Signature

CHRISTIE R SIMMONS
Notary Name, Printed, Typed, or Stamped
Notary Public, State of Indiana
Commission Number NP0719556
My Commission Expires
April 03, 2027

Commission Number: NP0719556

My Commission Expires: April 3, 2027

SCRUTINIZED COMPANIES
CERTIFICATION PURSUANT TO
FLORIDA STATUTE § 215.4725 AND § 215.473



299 Prather Lane, PO Box C, Sellersburg, IN 47172 USA
Phone: 812/246-3371 Fax: 812/246-5446
www.centuryindustries.com

I, MICHELLE McROE, on behalf of CC
Print Name

certifies that CENTURY INDUSTRIES does not:
Company Name

1. Participate in a boycott of Israel; and
2. Is not on the Scrutinized Companies that Boycott Israel list; and
3. Is not on the Scrutinized Companies with Activities in Sudan List; and
4. Is not on the Scrutinized Companies with Activities in the Iran Petroleum Energy Sector List; and
5. Has not engaged in business operations in Cuba or Syria.

[Signature]
Signature

SOLTS MANAGER
Title

X12
Phone

8/6/19
Date



2019 Florida Annual Resale Certificate for Sales Tax

DR-13
R. 10/18

This Certificate Expires on December 31, 2019

Business Name and Location Address

Certificate Number

CENTURY INDUSTRIES INC
4514 BUD PRATHER RD
SELLERSBURG, IN 47172-9724

78-8012077935-3

By extending this certificate or the certificate number to a selling dealer to make eligible purchases of taxable property or services exempt from sales tax and discretionary sales surtax, the person or business named above certifies that the taxable property or services purchased or rented will be resold or re-rented for one or more of the following purposes:

- Resale as tangible personal property.
- Re-rental as tangible personal property.
- Resale of services.
- Re-rental as commercial real property.
- Incorporation into tangible personal property being repaired.
- Re-rental as transient rental property.
- Incorporation as a material, ingredient, or component part of tangible personal property that is being produced for sale by manufacturing, compounding, or processing.

Your *Florida Annual Resale Certificate for Sales Tax* (Annual Resale Certificate) allows you or your representatives to buy or rent property or services tax exempt when the property or service is resold or re-rented. You **may not** use your Annual Resale Certificate to make tax-exempt purchases or rentals of property or services that will be used by your business or for personal purposes. Florida law provides for criminal and civil penalties for fraudulent use of an Annual Resale Certificate.

As a seller, you must document each tax-exempt sale for resale using one of three methods. You can use a different method each time you make a tax-exempt sale for resale.

1. Obtain a copy (paper or electronic) of your customer's current Annual Resale Certificate.
2. For each sale, obtain a transaction authorization number using your customer's Annual Resale Certificate number.
3. Each calendar year, obtain annual vendor authorization numbers for your regular customers using their Annual Resale Certificate numbers.

Online: Visit floridarevenue.com/taxes/certificates

Phone: 877-357-3725 and enter your customer's Annual Resale Certificate number

Mobile App: Available for iPhone, iPad, Android devices, and Windows phones.

CERTIFICATE OF LIABILITY INSURANCE

THIS CERTIFICATE IS ISSUED AS A MATTER OF INFORMATION ONLY AND CONFERS NO RIGHTS UPON THE CERTIFICATE HOLDER. THIS CERTIFICATE DOES NOT AFFIRMATIVELY OR NEGATIVELY AMEND, EXTEND OR ALTER THE COVERAGE AFFORDED BY THE POLICIES BELOW. THIS CERTIFICATE OF INSURANCE DOES NOT CONSTITUTE A CONTRACT BETWEEN THE ISSUING INSURER(S), AUTHORIZED REPRESENTATIVE OR PRODUCER, AND THE CERTIFICATE HOLDER.

IMPORTANT: If the certificate holder is an ADDITIONAL INSURED, the policy(ies) must have ADDITIONAL INSURED provisions or be endorsed. If SUBROGATION IS WAIVED, subject to the terms and conditions of the policy, certain policies may require an endorsement. A statement on this certificate does not confer any rights to the certificate holder in lieu of such endorsement(s).

PRODUCER USI Insurance Services LLC-CL 950 Breckenridge Lane Suite 50 Louisville, KY 40207		CONTACT NAME: USI Insurance Services PHONE (A/C, No, Ext): 502.815.5200 FAX (A/C, No): 855.209.1246 E-MAIL ADDRESS:	
INSURED Century Industries LLC PO Box C Sellersburg, IN 47172		INSURER(S) AFFORDING COVERAGE	NAIC #
		INSURER A : Cincinnati Specialty Underwriting	13037
		INSURER B : StarStone National Insurance Company	25496
		INSURER C : Cincinnati Insurance Company	10677
		INSURER D :	
		INSURER E :	
		INSURER F :	

COVERAGES **CERTIFICATE NUMBER:** **REVISION NUMBER:**

THIS IS TO CERTIFY THAT THE POLICIES OF INSURANCE LISTED BELOW HAVE BEEN ISSUED TO THE INSURED NAMED ABOVE FOR THE POLICY PERIOD INDICATED. NOTWITHSTANDING ANY REQUIREMENT, TERM OR CONDITION OF ANY CONTRACT OR OTHER DOCUMENT WITH RESPECT TO WHICH THIS CERTIFICATE MAY BE ISSUED OR MAY PERTAIN, THE INSURANCE AFFORDED BY THE POLICIES DESCRIBED HEREIN IS SUBJECT TO ALL THE TERMS, EXCLUSIONS AND CONDITIONS OF SUCH POLICIES. LIMITS SHOWN MAY HAVE BEEN REDUCED BY PAID CLAIMS.

INSR LTR	TYPE OF INSURANCE	ADDL INSR	SUBR WVD	POLICY NUMBER	POLICY EFF (MM/DD/YYYY)	POLICY EXP (MM/DD/YYYY)	LIMITS
A	<input checked="" type="checkbox"/> COMMERCIAL GENERAL LIABILITY <input type="checkbox"/> CLAIMS-MADE <input checked="" type="checkbox"/> OCCUR <input checked="" type="checkbox"/> BI/PD Ded: \$5,000 GEN'L AGGREGATE LIMIT APPLIES PER: <input type="checkbox"/> POLICY <input checked="" type="checkbox"/> PROJECT <input type="checkbox"/> LOC OTHER:			CSU0113791	05/01/2019	05/01/2020	EACH OCCURRENCE \$1,000,000 DAMAGE TO RENTED PREMISES (Ea occurrence) \$100,000 MED EXP (Any one person) \$5,000 PERSONAL & ADV INJURY \$1,000,000 GENERAL AGGREGATE \$2,000,000 PRODUCTS - COMP/OP AGG \$2,000,000 \$
C	AUTOMOBILE LIABILITY <input checked="" type="checkbox"/> ANY AUTO OWNED AUTOS ONLY <input type="checkbox"/> HIRED AUTOS ONLY <input checked="" type="checkbox"/> Comp Ded <input checked="" type="checkbox"/> Coll Ded <input type="checkbox"/> SCHEDULED AUTOS NON-OWNED AUTOS ONLY			ENP0132948	05/01/2018	05/01/2021	COMBINED SINGLE LIMIT (Ea accident) \$1,000,000 BODILY INJURY (Per person) \$ BODILY INJURY (Per accident) \$ PROPERTY DAMAGE (Per accident) \$ \$1000/ \$1000 \$
B	<input type="checkbox"/> UMBRELLA LIAB <input checked="" type="checkbox"/> EXCESS LIAB <input type="checkbox"/> OCCUR <input checked="" type="checkbox"/> CLAIMS-MADE <input type="checkbox"/> DED <input checked="" type="checkbox"/> RETENTION \$0			84952X191ALI	05/01/2019	05/01/2020	EACH OCCURRENCE \$5,000,000 AGGREGATE \$5,000,000 \$
C	WORKERS COMPENSATION AND EMPLOYERS' LIABILITY ANY PROPRIETOR/PARTNER/EXECUTIVE OFFICER/MEMBER EXCLUDED? (Mandatory in NH) If yes, describe under DESCRIPTION OF OPERATIONS below			EWC048593900	05/01/2018	05/01/2021	<input checked="" type="checkbox"/> PER STATUTE <input type="checkbox"/> OTHER E.L. EACH ACCIDENT \$1,000,000 E.L. DISEASE - EA EMPLOYEE \$1,000,000 E.L. DISEASE - POLICY LIMIT \$1,000,000

DESCRIPTION OF OPERATIONS / LOCATIONS / VEHICLES (ACORD 101, Additional Remarks Schedule, may be attached if more space is required)

CERTIFICATE HOLDER City of Coconut Creek - Purchasing & Contracts Division Risk Manager 4800 W Copana Rd. Coconut Creek, FL 33063	CANCELLATION SHOULD ANY OF THE ABOVE DESCRIBED POLICIES BE CANCELLED BEFORE THE EXPIRATION DATE THEREOF, NOTICE WILL BE DELIVERED IN ACCORDANCE WITH THE POLICY PROVISIONS. AUTHORIZED REPRESENTATIVE 
--	--

Century Industries

BID #08-14-19-11

299 Prather Lane
 PO Box C
 Sellersburg, IN 47172
 Phone 812-246-3371 Fax 812-
sumit@centuryindustries.com

SALESPERSON	QUOTE DATE:
Michelle McRae	8/8/2019

MSM2800 "ShowMaster" 2000 SERIES

28ft long enclosed stage body
 18" deep steel channel mainframe
 60,000 lb. capacity pintle towing coupler
 17,500 lb capacity crank tongue jack
 Tandem axle suspension with (4) highway rated tires, electric brakes
 (4) 25,000 lb capacity corner leveling jacks
 Frame mounted level gauges
 Rugged, all-weather FRP sound shell enclosure
 28ft fold-down stage deck with skid resistant surface pattern, leveling legs, 125lb. live load capacity, hydraulic operation
 Stage canopy extends beyond main stage for maximum protection, hydraulic operation with secondary safety locks.
 Self-contained 12VDC hydraulic system with remote operation pendant
 Curb-side frame-mounted locking compartments for hydraulic and electrical systems
 (2) diamond plate steel stairs with enclosed risers and hand rails
 Highway lighting package with DOT marker and signal lights
 AC electric system with power cable, breaker panel, receptacles, and (2) rows of dual tube fluorescent stage lighting
 Neatural medium gray stage deck color to reduce heat build-up from the sun
 Neatural medium gray stage interior for reduced glare and enhanced neutral appearance
 Gel-coat exterior for UV protection and vandal resistance

1 MSM2800 - BASE UNIT (14' x 28')

Item #	Pkg.	
20528	1	Premium Anti-Corrosion Package Upgrade
10208	1	Premium Stair Upgrade
90636	1	Stage Deck Support Truss
51002	1	7,000 Watt Enclosed Generator - Gasoline
70002	1	Exterior Graphics -(28') Standard Pkg.
70003	1	Interior Graphics - Standard Pkg.
10209	1	Handicapped ADA Lift
56060	1	Decorative Stage Skirt, 56ft. (Main Stage Deck)
	1	(1-Day) On-Site Training

MSM2800 Base Unit w/ Accessories
 (w/) FOB Shipping

TOTAL \$ 122,908

ADDITIONAL SOLUTIONS - MSM2800

HYDRAULIC LEVELING			
90550		Hydraulic Leveling/Support System	\$ 9,255
84444		Hydraulic Hitch Jack	\$ 2,154
90551		Wireless Remote Control	\$ 2,126
BUILT-IN GENERATOR			
51005		8,000 Watt Enclosed Generator - Diesel	\$ 11,283
51006		12,000 Watt Enclosed Generator - Diesel	\$ 15,900
THEATRICAL SYSTEMS			
42014		PRO-1 LED Light Pkg., Qty.8	\$ 6,898
42015		PRO-2 LED Light Pkg., Qty.16	\$ 12,185
42101		LED Light Support Bars, (Per Pair)	\$ 1,194
42010		Powered Movie Screen w/ Projector Hardware	\$ 4,431
SOUND SYSTEMS			
41110		Pro-1 Sound System Pkg.	\$ 3,452
41111		Pro-2 Sound System Pkg.	\$ 5,323
41112		Pro-3 Sound System Pkg.	\$ 8,954
91104		Speaker Hanging Hardware, (Qty.2)	\$ 392
51110		AV Cabinet (Built-In)	\$ 4,191
90449		Drum Riser	\$ 2,061
42011		4'W x 8'L - Sound Diffuser Curve Tiles, (Qty.5)	\$ 4,670
ELECTRICAL			
42201		Electrical Stage Upgrade Package #1	\$ 3,233
51007		220V/200 Amp Panel Box	\$ 1,273
40030		120V Duplex Receptacle, (Qty.2)	\$ 412
40028		Exterior Flood Light, (Qty.3)	\$ 591
40029		Compartment Light, (Qty.2)	\$ 356
STAGE EXTENSIONS			
20202		4' x 8' Ext. Sections, (Qty.7)	\$ 8,085
56060		Decorative Stage Skirt, 16 ft.	\$ 592
GRAPHICS & MESH BANNERS			
90935		Verticle Hanging Mesh Banners, (Qty.2)	\$ 1,558
91102		Banner Hardware Pkg.	\$ 1,728
90917		28' -Folding Canopy Marquee, (Graphics Not Included)	\$ 3,919
ADDITIONAL ACCESSORIES			
11003		Deck Tie-Downs, Six (6)	\$ 696
10235		60" Equipment Storage Locker	\$ 1,234
10139		Personnel Door	\$ 1,997
90920		12' Alum. Equipment Loading Ramp	\$ 2,016
51111		5th Wheel Coupler	\$ 3,993
70104		Goose Neck Hitch	\$ 3,993
90553		Spare Tire Mount Bracket	\$ 337
TIR2002		Spare Tire	\$ 746
		(1-Day) On-Site Training	\$ 1,800

ShowMaster



Mobile
Community
Staging



ShowMaster™

MOBILE SOUND SHELL COMMUNITY STAGES

Add a professional dimension to your outdoor events while saving time and man power **Century's ShowMaster Mobile Community Stages** offer a mobile acoustic shell stage featuring unmatched sound, lighting and visual controls, permitting a variety of outdoor special events and performances throughout your entire community.

An onboard, self-contained, hydraulic actuation system permits fast, easy, one-person push-button setup for a stage that is ready to go whenever needed.

A choice of stage models permits you to select the stage size best suited to your event and performance needs.

ShowMaster™ Mobile Stage Features

- **Smooth, Seamless Shell** – rugged, damage-resistant stage enclosure with an attractive professional appearance providing a visual backdrop, weather protection, sound and lighting control, plus security during between events. Acoustically active panels enhance audience experience during outdoor performances. Neutral gray interior color enhances skin tones while reducing glare. Smooth, seamless body panels are ideal for large, highly visible promotional graphics.
- **All-Weather Stage Deck** – exclusive seamless, composite Duradeck provides a sound dampened, textured surface. Folding front stage deck is the same length as the rear main deck permitting one-person setup, as no additional assembly is required to achieve the full rated stage width. Stage deck height is adjustable using the built-in leveling jacks. Neutral gray deck color remains cool in direct sun unlike black stage decks.
- **Full-Length Stage Canopy** – extends beyond the front edge of the folding stage deck and the stage sides, providing maximum coverage and weather protection for the stage area on the three crucial sides, while also positioning the stage lighting beyond the end of the stage for optimum illumination of the stage area and performers.
- **Safety Features** – ShowMaster™ stages incorporate numerous safety features including dual canopy locking systems, control safety switches, and the industry's highest independently certified wind-load capacity.



Side View



Front View

Top View

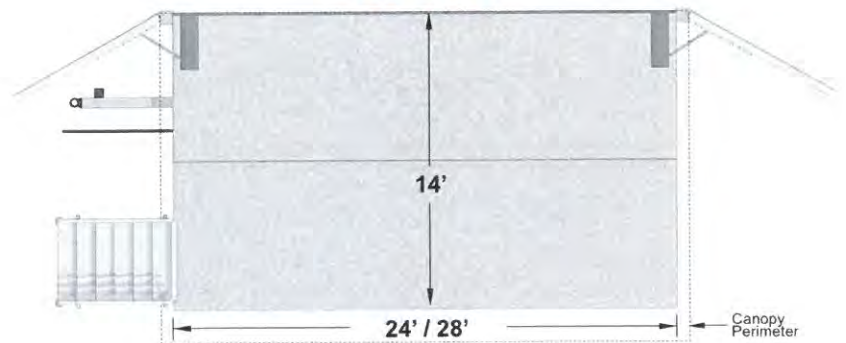

Century Industries
MSM2000 Series
ShowMaster
Mobile Sound Shell

ShowMaster? Mobile Stage Standard Features

- **Self-contained hydraulic system** – with remote control pendant, deep-cycle batteries, and battery charger, for fast, easy, one-person set up.
- **Powered protective canopy** - extends beyond the front edge and sides of the stage for full coverage, includes automatic mechanical and hydraulic dual-safety canopy locking systems.
- **Powered stage deck** - all-weather folding stage deck that is equal in length to the main rear stage deck.
- **Highway Rated Tires** - includes electric brakes on four wheels.
- **Heavy-duty tandem axle suspension** - equalizer system allows towing over curbs and rough ground.
- **Pintle towing coupler** – rugged lunette ring coupler. (ball coupler available on request)
- **Heavy-duty Tongue Jack** – mounted on trailer tongue.
- **Rugged support frame** – dual 18” deep steel-channel backbone main-frame.
- **Crank leveling/support jacks** - four (4) 25,000lb capacity, corner jacks pivot for extra ground clearance during towing and reduced cranking during setup.
- **Breaker panel** – 125 amp capacity, (3) 20 amp breakers, 50ft of 10/3 W cable, receptacles at each inside end of stage, and in mechanical compartment.
- **LED stage lighting** – two rows of dual-tube fluorescent lights mounted at front edge of canopy and at the canopy hinge line providing maximum stage and performer illumination.
- **Storage lockers** – two curb-side compartments with locking hardware for equipment and systems security.
- **Stairs** – (2) sets of steel stairs with enclosed ADA tread-plate treads, adjustable leveling legs, and removable safety handrails on two sides.
- **DOT required** - signal, marker lights, reflectors, and license light, with 12VDC connector cable.
- **Certified by Structural Engineer (IBC2012)**

Model	Stage Size
-------	------------

MSM2800 14'D x 28'L

Options

Recommended Options



Adjustable Acoustic Wall Panels – mounted at stage left and stage right, movable panels pivots from closed Clocked position through 270 degrees. then opened, hinged panels increase the visual backdrop by 16 ft., increase audience viewing angles, improve sound control by directing and focusing sound toward audience, improve the acoustic environment for performers, provide a back drop for sound wings, and permit loading access when stage deck and canopy are closed. Adjustable lock bars allow a choice of secured positions. manels lock for security.....

90650



Premium Anti-Corrosion Package – provides increased corrosion resistance reducing maintenance and increasing stage life. All steel frame members shall be hot dipped galvanized for maximum corrosion protection. eardware upgrades include anodized aluminum perimeter stage rail, galvanized deck hinge and stainless steel fasteners.

MSM2400
MSM2800
MSM3200
MSM3600

20524
20528
20532
20536



Premium Stair Upgrade – upgrade from painted steel to welded 1/8" and 3/16" aluminum plate stairs for lighter weight and rust-free corrosion resistance. Adjustable footpads shall be provided at the bottom of stairs to accommodate uneven ground. stairs shall attach to movable stage sections and to all sides of the main folding stage deck. removable handrails shall be anodized aluminum. stairs shall have fully enclosed risers between threads. 36" wide stair. (Qty.2).....

10208



Stage Deck Support Truss – 19" deep galvanized steel support truss is attached to the understructure of the fold-down stage deck, and extends the length of the stage deck. A linkage automatically extends the truss as the stage deck lowers, maintaining the truss position perpendicular to the ground. Truss features fast, two-point leveling. deck truss upgrade replaces the standard multiple deck support legs, quickly producing a stage deck that is both level and straight, significantly reducing set up time.

90636

Options

Accessories



Handicapped Access Lift – installed at the back stage door , always available and readily accessible, lift provides wheel chair accessibility from ground level to stage deck level. Lift is hydraulically actuated and is controlled by a remote pendant with a 6ft cable. Lift platform is 45" long x 30" wide, and features a slip resistant surface. Lift platform stows inside the rear door and is supplied with a gray cover. Lift capacity is 700lbs

10209



Personnel Door – double-wall, welded aluminum entrance door mounted on stage backwall with full length hinge and locking stainless steel hardware.

10139

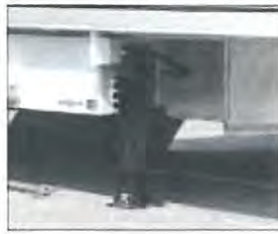

Hydraulic Leveling/Support System – upgrades corner leveling jacks to push-button hydraulic actuation with four (4) corner mounted 16,000 lb. capacity (each) jacks. Each jack to have a pilot operated lock valve the hydraulically locks the jack leg position in the event of a hydraulic failure. Jacks pivot 90 degrees for increased ground/curb clearance during towing, preventing damage to the jacks while significantly increasing the amount of effective jack travel available to level or raise the stage.....

90550

Options

Equipment & Accessories

Wireless Remote Control – compact twelve (12) button remote control allows complete freedom to move around the stage during set up for improved view. Remote operates stage through discrete frequencies and ID codes enhancing safety. Control operates stage canopy, stage deck, and optional hydraulic leveling/support jacks if installed.	90551
Hydraulic Hitch Jack – upgrade the standard tongue jack to a push-button 16,000lb capacity hydraulically operated jack, permitting fast, easy, safe disconnection from the tow vehicle	84444
Flush Equipment Tie - Down – flush deck mounted tie-downs secure equipment inside stage during transport. 1,500lb minimum pull capacity. \$/Ea	11003
Decorative Stage Skirt – encloses lower perimeter of stage deck enhancing appearance for audience. Skirt is 100% synthetic fiber for maximum weather, mildew, and soil resistance, and easy care and handling. Velcro attachment and heavily weighted for wind. Price per foot	56060
4'x 8' All-weather Stage Extension Section – has weather-resistant Duradeck surface with non-skid pattern to match mobile stage deck. Each section is framed with a rust-free, heavy-duty 7" high extruded aluminum channel. freestanding sections are supported by four (4) adjustable leveling support legs. back leg has both coarse and fine height adjustments. extension sections attach to each other, to the stage perimeter, and will accommodate stairs. Three (3) connector clamps are included with each stage extension section	20202
60" Equipment Storage Locker – provides secure storage for equipment in a large weather-tight compartment. Locker door is attached to frame by concealed hinge and is secured by large stainless steel "D" ring latch with keyed lock. Compartment door is weather sealed. 60"l x 20"h x 25"d.....	10235
Equipment Loading Ramp – 12'l x 35"w lightweight aluminum loading stage ramp is lightweight for easy portability. Ramp is designed to provide a smooth transition from ramp to the ground. Ramp deck provides superior traction. Ramp attaches to the stage perimeter.....	90920

Options

Transport

Spare Tire – Full-size spare tire and wheel match the vehicle's original tire dimensions.....	TIR2002
5th Wheel Hitch	51111
Gooseneck Hitch	70104
Air-ride suspension – Provides smooth tow quality. Upgrading replaces conventional steel springs to Air Ride Suspension you can achieve increase both comfort and load capacity simultaneously. Model: HT190U/HS190U. Capacity 20,000 lbs (9,000 kg).....	12115

Options

Electrical

Electrical Upgrade Package #1 – breaker panel and receptacle upgrade for MSM series stages, includes base electrical system, main breaker with ten (10) additional circuit breakers, sixteen (16) receptacles mounted in front edge of canopy on eight (8) circuits, and two (2) duplex receptacles mounted in canopy rear on two (2) circuits. Power cord is upgraded to 50 ft of 6/4t cable.	42201
220V/200 Amp Panel Box – Single phase, 3 wire, 24 circuits, 6 single pole breakers and 2 double pole breakers, copper bus, 120/240 Volts ac. 22,000 interrupting capacity. Suitable for use for larger bands with sound equipment.....	51007
120V Duplex Receptacle – Tamper resistant GFCI outlets are installed along back stage wall when extra power is required. GFCI outlets are used in outdoor location where the risk of electrical shock is higher than usual. Tamper resistant design prevents small items from entering electrical devices and shocking someone. \$/Ea.....	40030
Solar Battery Charger – helps maintain battery charge and reconditions batteries for longer service life whenever stage is exposed to sunlight. Note: not intended to power hydraulic system or recharge fully discharged batteries.	
7,000 Watt Enclosed Generator Package – gasoline fueled generator is fully enclosed in a locking frame mounted exterior compartment with sound proofing for extra quiet operation. Includes hour meter, electric start, and fuel tank. Built - in generator is always on board when needed and does not need to be lifted on and off stage deck. Powers 42006 & 42008 lighting packages.	51002
8,000 Watt Enclosed Generator Package – 120V/240V, 66.6/33.3 amp 60Hz, air cooled diesel generator is frame mounted in built - in locker box compartment. Meets National Park Service Sound Level Requirements (60 dB(A) at 50 ft). <i>(Available on all MSM stage models.)</i>	51005
12,000 Watt Enclosed Generator Package – 120V/240V 100/50 Amp 60Hz, air cooled diesel generator is frame mounted in built - in locker box compartment. Meets National Park Service Sound Level Requirements (60 dB(A) at 50 ft). <i>(Available on MSM3200 & MSM3600 stages).</i>	51006
Exterior Flood Light – provides (3) lights for safety and working during night hours. Light has a shock-absorbing weatherproof body that will not rust, dent, or scratch. Light is fully adjustable for aiming. 12VDC/3.2 Amps. Switch controlled, self - contained operation provides light when stage is not plugged into AC power source. Lights are mounted on stage curbside and hitch and to allow nighttime loading and safe towing hook-up. \$/Ea.....	40028
Compartment Light – light is mounted inside stage providing light for working or loading during night time hours. Multi - position switch allows high, low, and off settings. 12VDC operation allows self-contained operation from the stage battery system. \$/Ea.....	40029
Theatrical Light Support Bar extends and supports theatrical light fixtures from the front edge of the stage canopy. Each weather resistant stainless steel "T" - bar support holds up to four (4) par fixtures, and pivots into canopy with lights attached) for secure storage during transport when not in use. One (1) pair of support bars is required for Basic and lighting package #1 (total of eight (8) par fixtures). Two (2) pair of support bars are required for intermediate and lighting package #2 (total of sixteen (16) fixtures). per pair	42101
Note: Support bar does not include PAR lights – see optional lighting packages	

Options

Video

9'X12' Movie Screen – electric/motorized screen is ideal for outdoor stage theater applications for commercial presentations. It is designed for ceiling installation. Motor in-the-roller design ensures a silent operation and the front access panel of the case allows easy access. electric screen offers preset adjustable limit switches to automatically stop the screen at the desired viewing level. Available in both 110 and 220 volt models. Includes standard control module level, 3-button wall switch with box and cover plate. <i>*(Movie Projector not included)</i>	42010
<ul style="list-style-type: none"> - Optional Wireless Remote – 3-button control infrared transmitter with receiver. 2 -AAA batteries included. pingle touch control operates up to 50 ft. away. - Radio Remote - Projector Canopy Hardware 	

Options**Theatrical Lighting Systems**

BASIC LIGHTING PACKAGE - Lighting Controller capable of handling up to 8 intelligent LED lights with up to 16 channels each • Increase design flexibility with 128 channels of DMX control. (8) PAR 56 LED tri-color weatherproof fixtures. (8) Fixture Clamps. (8) Safety Cables. (7) Outdoor rated, power extensions. (7) Data Extensions, Outdoor rated. (1) 3-Pin DMX Cable 50'0.

(Note: Theatrical Light Support Bars #42101 are sold separately.) **42012**

INTERMEDIATE LIGHT PACKAGE - (1) Lighting Controller capable of controlling up to 12 intelligent LED lights with up to 16 channels each • Includes 192 channels and 30 banks of 8 scenes for a maximum of 240 scenes. (16) Tri 12 LED Light Fixtures outdoor-rated, tri-color LED Weatherproof fixtures. (16) Fixture Clamps, (16) Safety Cables, (15) Meter Power Extensions, (15) Meter Data Extensions, (2) 3-Pin DMX Cable 50'0.

(Note: Theatrical Light Support Bars #42101 are sold separately.) **42013**

PROFESSIONAL THEATRE LIGHTING PACKAGE #1 - (1) Theater-style Lighting Controller designed to control LED Par fixtures as well as relay and dimmer packs • Saves space by squeezing 48 channels into a 24-channel console • Achieve smooth transitioning between live stage looks with built-in, two-scene cross faders • Increase programming and playback versatility with two programmable auxiliaries • Simplify programming by using DMX channel patching to reassign channels • Increase flexibility with built-in MIDI support for remote dimming and scene triggering • Coordinate your light shows to music using the direct audio input connector. (8) Tri 24 LED Light Fixtures - outdoor-rated, tri-color LED wash light designed for any outdoor event • Weatherproof fixtures perfect for outdoor events. (8) Fixture Clamps, (8) Safety Cables, (7) Meter Power Extensions, (7) Meter Data Extensions, (1) 3-Pin DMX Cable 50'.

(Note: Theatrical Light Support Bars #42101 are sold separately.) **42014**

PROFESSIONAL THEATRE LIGHTING PACKAGE #2 - (1) Theater-style, Lighting Controller designed to control LED Par fixtures as well as relay and dimmer packs • Saves desk space by squeezing 48 channels into a 24-channel console • Achieve smooth transitioning between live stage looks with built-in, two-scene cross faders • Increase programming and playback versatility with two programmable auxiliaries • Simplify programming by using DMX channel patching to reassign channels • Increase flexibility with built-in MIDI support for remote dimming and scene triggering • Coordinate your light shows to music using the direct audio input connector or built-in microphone • Ability to stack scenes for simultaneous or sequential playback. (16) Tri 24 LED Light Fixtures - outdoor-rated, tri-color LED wash light designed for any outdoor event • Weatherproof fixtures perfect for outdoor events. (16) Fixture Clamps, (16) Safety Cables, (15) Meter Power Extensions, (15) Meter Data Extensions, (2) 3-Pin DMX Cable 50'.

(Note: Theatrical Light Support Bars #42101 are sold separately.) **42015**

Options**Sound Systems**

PRO-SOUND SYSTEM #1 - (1) 12-Channel Sound Mixer Console features a versatile all-in-one console that can handle up to 12 inputs with internal effects. 12 Input channels (6 Mics + 4 Stereo line inputs), 3 band EQ (Ch 1-7/8), 2 band EQ (Ch 9/10-11/12), 4 busses (Stereo + 2 groups), 1 Aux send + 1 Effect send, 1 Stereo Aux return, SPX Digital multi effects, XLR Connectors, Light weight (3.2 kg) (2) Sound Speakers are 225W amp to power the 12" woofer and a 75W amp to power the 1.75" compression driver. With a frequency range of 50Hz to 20kHz and a max. SPL of 121dB. Equipped with a 2-band EQ. The powered subwoofer has a built in high pass filter. (2) 50' speaker cables. (2) Sound Speaker Stands - Set of Two with Bag. (2) Microphone Stands w/Telescoping Boom. (2) Shure Microphone's. (4) 50' Mic Cables.....

41110

PRO-SOUND SYSTEM #2 - (1) 16-Channel Mixing Console., 6 busses, and all the outstanding digital effects you'll need built in. 16 Input channels (10 Mics + 4 Stereo line inputs), 3 band Mid-sweep EQ (Ch 1-8), 3 band EQ (Ch 9/10-15/16), 6 busses (Stereo + 4 groups), 2 Aux sends + 1 Effect send, 1 Stereo Aux return, SPX Digital multi effect, XLR Connectors, Light weight (5.5 kg), Rack Mountable. (2) Sound Speakers Bi-amplified 12" cone type woofer and 1.75" compression driver deliver total output power of up to 400 watts (LF: 300 watts, HF: 100 watts burst. Input level range from -36 dB to +4 dB accepts output from your mixer as well as microphones, synthesizers, or other electronic musical instruments. (2) Tripod Speaker Stands, Min / Max Height: 48/81 Inches (1219/2057 mm) (4) Microphone Stands, Min / Max Height: 6/99 Inches (152/2515 mm) (4) Hand Microphones W/Switch (6) 50' Mic. Cables.....

41111

PRO SOUND SYSTEM #3 - (1) 24-Channel Premium Mixing Console. 16 Mic Inputs with 48V Phantom Power and HPF per Channel, 24 Line Inputs (16 mono and 4 stereo), 6 AUX Sends + 2 FX Sends, 4 GROUP Buses + ST Bus, 2 Matrix out, 1 Mono out. (1) Power Amplifier delivers 3200 watts. Independent sweepable high-pass and low-pass filters on each channel so you can optimize output for subwoofer or full range systems. (4) Weatherized Sound Speakers with high-impact polypropylene enclosure. Up to four anchor-plate attachments. High sensitivity, 131 dB maximum SPL. Power handling: 600 W continuous, 2400 W peak (1) CD player features USB port on front panel for iPod and other devices. iPod compatibility. CD-R/RW disc playback compatibility. MP3 and WMA compatibility with numerous convenient playback functions. (4) Tripod Speaker Stands, Min / Max Height: 48/81 Inches (1219/2057 mm) (2) Microphone Stands, Min / Max Height: 6/99 Inches (152/2515 mm) (2) Hand Microphones W/Switch (2) 25' Speaker Cables (2) 50' Speaker Cables (2) 50' Mic. Cables.....

41112

Options

Sound Systems

Hanging Speaker Hardware Package – Stainless steel brackets that offer the perfect support for a variety of speakers to hang from front of the Showmaster stage.....	91104
Sound Diffuse CURVE Tiles – removable light weight 4x8 help dampen reflective reverberation problems and reduce overall ambient or unwanted monitor feedback and hot-spot reflection points to effectively clean up sound. Panels attach to stages back rear wall, weather resistant w/washable fabric material and variety of colors to choose from. \$/Ea.....	42011
<i>**Optional graphic image printing available. Panels will not only take care of your sound issues, but can add extra flair and style to the interior stage.</i>	
AV Cabinet/Built-In - audio/visual cabinet with (6) angled shelves, electric receptacle, fluorescent cabinet light, door with locking stainless steel 'D' ring handle, welded .090 aluminum construction painted to match stage interior, 72" high, 36" wide, 24" deep.	51110
Drum Riser - Provides height for drummers that want to rise above the crowd. Sturdy, lightweight and compact. Kit consists of (2) 4'x8' sections with 6" legs.....	90449

Options

Graphics



Custom Exterior Stage Graphics – increase your visibility, promote your community, organization, and sponsors with custom designed exterior graphics that are visible when ever the stage is on the road or set up for an event	70002
Custom Interior Stage Graphics – promote your community, organization, and sponsors with custom designed interior graphics that are visible when ever the stage is open for an event	70003
Hanging Banners – event banners hang from each end of stage canopy (1) Pair.....	91103
Canopy Marquee – folding marquee sign mounted above front edge of canopy. Sign extends canopy length. Fluorescent lighting provides night time illumination. <i>(Does not include graphics)</i>	90916 - 24 90917 - 28 90918 - 32 90919 - 36
Banner Hanging Hardware – (1) Pair.....	91102



PO Box C Sellersburg, IN 47172 USA
 800/248-3371 812/246-3371
www.centuryindustries.com

GSA & CMAS

Prices and specifications are subject to change without notice

REGULAR INSPECTIONS

EACH TRIP

- Proper Loading
- Hydraulic Hose Condition
- Coupler/Hitch Condition
- Trailer Connection
- Wall Panels - Scratches & Gouges

MONTHLY INSPECTION

- Hydraulic Fluid Level
- Battery Condition
- Spring Hanger And Suspension Bolts
- Door Closures

ANNUAL INSPECTION

- Trailer Marker And Signal Lights
- Electric Brake Operation
- Tire, Wheel And Suspension Conditions
- Hinge Lubrication
- Door Latch/Lock Lubrication
- Wheel Bearings
- Brake Condition
- Jack Gear Lubrication
- Stage Clamp Lubrication
- Coupler Lubrication
- Lubricate Adjustable Leveling Pads On Stairs, Stage Deck, And Extension Sections

NOTIFICATION OF SAFETY DEFECTS

If you believe that your vehicle has a defect that could cause a crash or could cause injury or death, you should immediately inform the National Highway Traffic Safety Administration (NHTSA) in addition to notifying COMPANY NAME.

If NHTSA receives similar complaints, it may open an investigation, and if it finds that a safety defect exists in a group of vehicles, it may order a recall and remedy campaign. However, NHTSA cannot become involved in individual problems between you, your dealer, or COMPANY NAME.

To contact NHTSA, you may either call the Vehicle Safety Hotline toll-free at 1-888-327-4236 (TTY: 1-800-424-9153), go to <http://www.safercar.gov>; or write to:

Administrator

NHTSA

1200 New Jersey Avenue S.E.

Washington, DC 20590

You can also obtain other information about motor vehicle safety from <http://www.safercar.gov>.

Century Industries

299 Prather Lane
 PO Box C
 Sellersburg, IN 47172

BID# 08-14-19-11

ALTERNATE #1 : 16' x 24' FR4300 - Bandstand Stage

SALESPERSON	QUOTE DATE:
Michelle McRae	March 03,2019

Simple Stage Setup - roof canopy raises and tilts hydraulically. Folding canopy and stage deck are equipped with hydraulic (2-Button) remote control to facilitate setup in (3 -min.) or less.

Clear sight lines: Canopy is free of vertical columns or post connecting the roof corners to the stage deck.

Protective canopy - full-coverage roof extends beyond the deck perimeter. Aluminum support structure is covered by rugged vinyl coated polyester fabric.

Stage deck - all-weather folding stage decks form 20ft or 24ft long stage.

Guardrails - removable aluminum guardrails are provided at rear of stage deck only.

Heavy-duty single-axle suspension - smooth towing with exceptional maneuverability. Electric brakes on all wheels.

Crank leveling/support jacks - heavy-duty frame mounted jacks provide stage leveling.

Deck support truss - folding decks are supported by welded aluminum leveling trusses for accurate expedited set up.

Enclosed mechanical compartment - welded aluminum compartment protects system components.

Breaker panel - 220V 125 amp capacity load center routes electrical power for stage.

LED up-lights - frame mounted 120V interior up-lights illuminate the stage roof and stage deck area.

Stairs - (1) aluminum treadplate stair with enclosed risers and handrails attaches to stage deck perimeter.

DOT required - LED signal, marker lights, reflectors, and license light, with 12VDC connector cable.

1 FR4324 (16'x24') - BASE UNIT

Item #	Pkg.	
90958	1	All Weather Transport Pkg.
10204	1	36" Additional Alum. Stairs
56060	1	Decorative Stage Skirt, 52 LF
10209	1	48" ADA Access Lift - (Above Deck)
51002	1	7000 Watt Enclosed Generator, (Built-In) Diesel
70008	1	Exterior Graphics Pkg., (Standard Pkg.)
	1	(1-Day On-Site Staff Training)

FR4324 Base Unit w/ Accessories
 (w/) FOB Shipping

TOTAL \$ 108,161

ADDITIONAL SOLUTIONS - 4300 - Bandstand Stage

Item #	Pkg.		UNIT PRICE
90921		4' X 8' Stage Extension Sections	\$ 1,224
11004		Deck Tie Downs, (Qty.1)	\$ 90
90920		Equipment Loading Ramp	\$ 2,016
90407		4' Long Aluminum Guardrails	\$ 808
90408		8'-0" Long Aluminum Guardrails	\$ 1,100
10241		36" Aluminum Storage Locker, (x14"D x14"T)	\$ 580
TIR1512		Spare Tire & Mount Frame	\$ 1,084
90982		Hitch Caster Wheel	\$ 605
90545		Hydraulic Leveling / Support Jacks, 12,000#	\$ 10,431
84447		Hydraulic Hitch Jack	\$ 2,154
40028		Exterior Led Flood Lights, (Qty.2)	\$ 591
ELECTRICAL			
42205		Electrical Upgrade Package #1	\$ 3,233
51007		220v/200 Amp Panel Box	\$ 1,273
40030		Electric Duplex Receptacle 120VAC (EA.)	\$ 206
91106		Solar Battery Charger, (Qty.2) w/ Hyd. Jacks	\$ 765
LIGHT PACKAGES			
42014		Professional LED Pkg.#1 - (8) LED Fixtures	\$ 6,891
42015		Professional LED Pkg.#2 - (16) LED Fixtures	\$ 12,132
42016		(6'-0") Hanging Truss Light Bar, (Qty. 2)	\$ 528
SOUND PACKAGES			
41110		Pro-Sound System #1	\$ 3,421
41111		Pro-Sound System #2	\$ 5,323
41112		Pro-Sound System #3	\$ 8,954
41113		(CURV) Line Array Sound System	\$ 18,746
41115		(RCF) Line Array Sound System	\$ 21,431
90957		800# Telescope Speaker Beams, (Qty.2)	\$ 907
90449		Drum Riser	\$ 2,061
42010		Powered Movie Screen w/ Projector Hardware (\$ 4,431
SUBTOTAL			
GRAPHICS & BANNERS			
90935		Verticle Banners, Mesh (Qty.2)	\$ 1,558
91102		Verticle Banners - <u>Hardware</u>	\$ 1,728
90445-24		24' Mesh Scrim (Rear)	\$ 4,176
91103		Marquee 42" Printed Banner, Mesh (Qty.1)	\$ 1,144
91111		Marquee Banner - <u>Hardware</u>	\$ 2,990
90990		Illuminated Marquee (LED) Light Strip	\$ 2,300
		(1-Day On-Site Staff Training)	\$ 1,800

FrontRow MOBILE STAGES 4300



Shown with
Optional Features

Patent Pending

Mobile Bandstand

FrontRow 4300 series mobile bandstand stages offer versatile outdoor staging in a compact, easy-towing package. Simplified, push-button, hydraulically actuated setup makes this stage series a great choice for a variety of community events and activities. Exceptional maneuverability allows these stages to be positioned in tight, limited-access locations.



FR4300 mobile bandstands are performer-friendly, featuring a roof canopy that extends beyond the stage deck on all four sides providing sun and weather protection for performers and equipment. Canopy is sloped away from the audience side of the stage, directing precipitation run-off to the rear. Canopy incorporates sound and lighting equipment attachment.

January 2019

An attractive appearance, all-weather construction, and setup simplicity make the **FR4300** series of mobile stages great performers.

Century  Industries

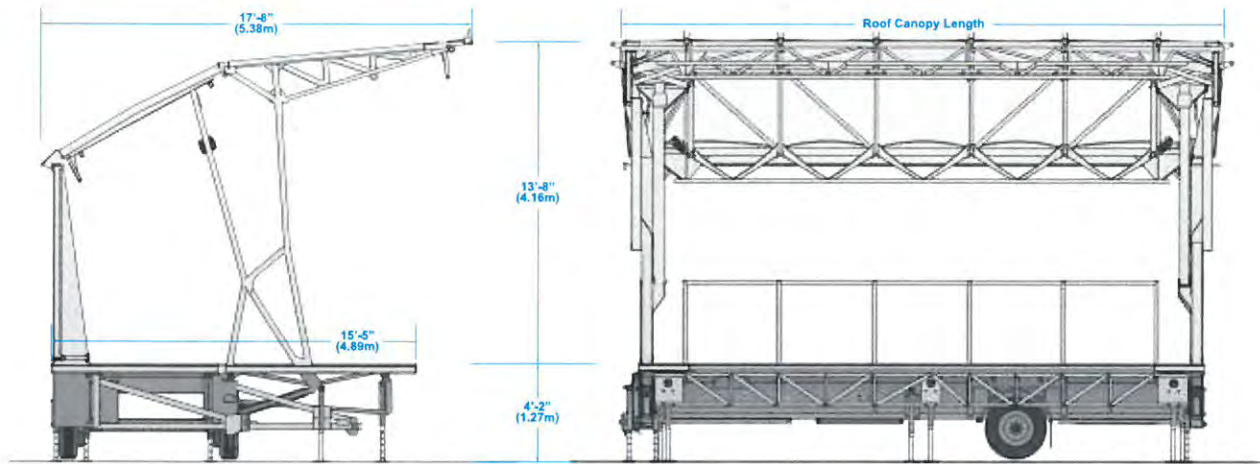

FrontRow 4300
Mobile Bandstand Stages

	FR4320	FR4324
Deck Length	20'- 0" (6.10m)	24'- 0" (7.32m)
Deck Depth	15'- 5" (4.70m)	15'- 5" (4.70m)
Canopy Height	13'- 8" (4.16m)	13'- 8" (4.16m)



Engineer Certified

Made in USA

Patent Pending

© COPYRIGHT 2014

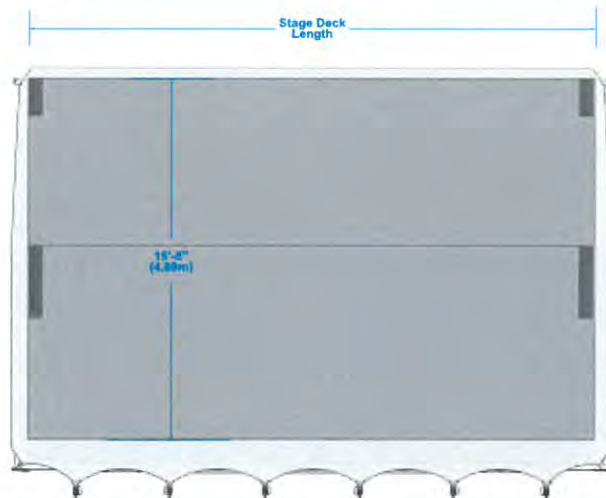

FrontRow FR4300 Mobile Bandstand Stage Standard Features

- **Simple Stage Setup** - roof canopy raises and tilts hydraulically (PATENT PENDING). Folding roof canopy and hinged stage deck section are hydraulically actuated for fast, easy setup.
- **Protective Canopy** - full-coverage roof extends beyond the deck perimeter. Canopy trusses and center support are 2" dia. tube for lighting attachment. Aluminum support structure is covered by rugged sound absorbing vinyl coated polyester fabric.
- **Stage Deck** - weather-resistant folding stage deck lowers to form nominal 16ft (4.70m) deep stage.
- **Guardrails** - removable aluminum guardrails are installed along rear of stage.
- **Heavy-Duty Single-Axle Suspension** - smooth towing with exceptional maneuverability. Electric brakes on all wheels.
- **Pintle Towing Coupler** - rugged lunette ring coupler (other hitch types available) mounted on fold-away towing hitch.
- **Heavy-Duty Tongue Tack** - crank jack mount on towing tongue
- **Rugged Main Frame** - corrosion-resistant welded aluminum main frame.
- **Crank Leveling/Support Jacks** - heavy-duty frame mounted jacks provide stage leveling.
- **Deck Support Truss** - folding deck is supported by welded aluminum leveling truss for accurate expedited set up.
- **Enclosed Mechanical Compartment** - welded aluminum compartment protects system components.
- **Breaker Panel** - 220V 125 amp capacity load center routes electrical power for stage.
- **LED Up-Lights** - frame mounted 120V interior up-lights illuminate the stage roof and stage deck area.
- **Stairs** - aluminum treadplate stair with enclosed risers and handrails attaches to stage deck perimeter.
- **DOT required** - LED signal, marker lights, reflectors, and license light, with 12VDC connector cable.
- **Stage Operation Training** - available by factory representative

MODEL	STAGE DECK (L x D)	TOW LENGTH	EMPTY WEIGHT	PRICE
FR4324	15' 5" X 24' (4.70 x 7.32m)	28.7' (8.75m)	7,320lbs (3320kg)	

Stairs - Additional	(1) set of welded aluminum stairs with fully enclosed risers, diamond-plate treads, and removable handrails. Adjustable footpads accommodate uneven ground. Stairs shall attach to optional stage sections and to the perimeter of the main stage deck.	10208
Equipment Loading Ramp	reduced weight 12'L x 35"W aluminum loading ramp attaches to stage perimeter facilitating placement of equipment on stage deck.	90920
4' x 8' Portable Stage Deck Extension Section	4'x 8' stage sections are constructed of weather-resistant 3/4" MDO with renewable top surface texture, and are framed with a heavy-duty extruded 4" high aluminum channel. Sections attach to each other, to the stage deck perimeter, and will accommodate portable stairs. Extension sections are supported by two (2) adjustable legs, permitting height adjustment or accommodation of uneven ground. Includes three (3) connector clamps and three (3) attachment brackets per section	90921
Drum Riser	8'x 8' riser is constructed of weather-resistant 3/4" MDO surface, framed with a heavy-duty extruded 4" high aluminum channel.	90449
ADA Handicap Lift (Above Deck)	48" vertical travel hydraulic powered wheelchair lift with 48" long x 35" wide non-skid platform is permanently mounted at taillight end of stage. Operated by a remote pendant with 6 ft long cord. Lift has a lifting capacity of 660 lbs.	10209
ADA Handicap Lift (Below Deck)	61" vertical travel hydraulic wheelchair lift with 53" long x 31" wide non-skid platform is permanently mounted under stage deck at taillight end of stage. Operated by a remote pendant with 6 ft long cord. Lift has a lifting capacity of 750 lbs.	90951
Guardrails	removable aluminum guardrail attaches to the stage deck perimeter rail with hand tightened clamps (no tools required). Available in 4 and 8 foot lengths. <ul style="list-style-type: none"> • 4ft Long Aluminum Guardrail • 8ft Long Aluminum Guardrail 	90407 90408
Storage Compartment	42" long x 14" deep x 14" tall welded aluminum, lockable storage compartment mounted to mainframe. (padlock not included)	10237
Cargo Bay Door	60" wide x 21" high enclosed welded aluminum storage compartment mounted within below-deck mainframe, provides storage for larger components. Holds up to four (4) 4 x 8 stage extension sections. Cargo bay is lockable, (padlock not included)	90986
Tongue Mounted Caster Wheel	tongue mounted caster wheel allows maneuvering and positioning of stage when stage is disconnected from tow vehicle.	90982
Hydraulic Leveling Jacks	upgrade stage corner leveling/support jacks to push-button hydraulic operation with four (4) 12,000 lb. minimum capacity (each) jacks controlled by a remote pendant. Provides fast, effortless stage leveling. Each jack shall be equipped with a high-floatation 8"x 8" foot pad. Upgrade exchange price	90545
Anemometer Mounting Hardware	tongue mounted caster wheel allows maneuvering and positioning of stage when stage is disconnected from tow vehicle.	91123
Deck-Mounted Tie-Downs	stage deck mounted flush tie-downs allow equipment to be secured to the stage deck for transport. Each tie-down is attached to the stage frame, and has a 1,500 minimum pull capacity. Price each	11003
Mounted Spare Tire	full size spare tire and wheel. Matches stage's original tire dimensions and specifications	TIR2002

Decorative Skirt	skirt encloses stage deck support structure for more attractive appearance. Boucle skirt is constructed of 100% synthetic fiber for maximum weather-ability, mildew resistance, soil resistance, easy care and handling. Skirt shall be fire retardant. Skirt is heavily weighted with 3/16" link coated chain to prevent excessive swaying. Choice of skirt colors.	50060
Weather Transport Package	<p>PVC coated polyester fabric rear windwall/media panel enclosure package offers stage protection during performances, transport, and storage. Includes rear mounted windwall and hinged media end panels that also double as enclosure panels when stage is closed. Adjustable end media panels may be locked open to display event or sponsor graphics during performances, or folded and locked out of sight.</p> <p>Rear windwall provides a rear stage visual and weather back drop. Grey color wind wall is fabricated from fire-retardant 18oz pvc coated polyester fabric. Windwall is removable when open stage back wall is desired.</p>	90958

Graphics & Banners

Marquee Banner	custom printed 42" tall color vinyl mesh material promoting community, event, or sponsors.	91103
Marquee Banner Hardware	vertical support posts with stainless steel cable system mounts to front canopy structure to support mesh banner. Banner hardware allows banner to be mounted either above or below front canopy roof.	91111
Side Hanging Vertical Banners	set of two (2) vertically hanging custom-printed mesh banners promote your community, event, and/or sponsors. Banners may be hung from banner support hardware or canopy support truss. Banners are wind and weather resistant.	90935
Side Hanging Banner Hardware	telescoping aluminum banner support pipes mounted on front canopy truss and front of stage deck. Pipes secure top and bottom edges of optional side vertical banners.	91102
Exterior Graphics	custom graphics, logos and signage applied to stage roof for promotion of your organization when stage is CLOSED for transport. Promote your community, organization and/or sponsors.	70002
Interior Graphics Allowance	custom graphics, logos and signage applied to rear stage windwall for promotion of your organization when stage is set up at an event. Promote your community, organization, event and/or sponsors.	70003

Options

Support

Stage Training

Factory Training	Factory training of your stage crew is available prior to stage shipment.
-------------------------	---

Electrical Upgrade Package #1	receptacle and breaker panel capacity upgrade includes Standard Electrical plus the following: <ul style="list-style-type: none"> • Main Breaker and four (4) additional 20 amp panel mounted circuit breakers • Three (3) receptacles mounted in canopy, (1) on each truss at hitch end • Two (2) Duplex receptacles mounted in canopy rear on two (2) circuits • Power cord, upgrade to 50'6/4 W. 	42201
Electric Receptacle	additional 120VAC/20 amp. duplex electric receptacle. (each)	40030
Panel Upgrade	200 amp capacity breaker panel - exchange for standard	51007
LED Light	exterior LED flood light, 12VDC	90929
Enclosed 8kW Diesel Generator	built-in 120V/240V 100/50 Amp 60Hz diesel powered, air cooled generator is frame mounted under stage deck. Generator is mounted on 4 point focalized vibration isolators to minimize vibration. Includes hour meter, electric start and fuel tank. Sound level below National Park Service Sound Limits (68 dB(A) at 10ft). For powering supporting theatrical equipment.	51005
Enclosed 12kW Diesel Generator	built-in 120V/240V 100/50 Amp 60Hz diesel powered, air cooled generator is frame mounted under stage deck. Generator is mounted on 4 point focalized vibration isolators to minimize vibration. Includes hour meter, electric start and fuel tank. Sound level below National Park Service Sound Limits (68 dB(A) at 10ft). For powering supporting theatrical equipment.	51006

Options

Theatrical Lighting

Professional LED Lighting Package #1	includes: (1) DMX controller designed to control LED Par fixtures as well as relay and dimmer packs, 48 channels in a 24-channel console, built-in two-scene cross faders, two programmable auxiliaries, reassignable channels, built-in MIDI support for remote dimming and scene triggering. Coordinates light shows to music using the audio input connector or built-in microphone. Stack scenes for simultaneous or sequential playback. <ul style="list-style-type: none"> • (8) outdoor-rated, tri-color LED wash lights, flicker-free operation • (8) Fixture Clamps • (8) Safety Cables • (7) Meter Power Extensions • (7) Meter Data Extensions • (1) 3-Pin DMX Cable 50' 	42014
Professional LED Lighting Package #2	includes: (1) DMX controller designed to control LED Par fixtures as well as relay and dimmer packs, 48 channels in a 24-channel console, built-in two-scene cross faders, two programmable auxiliaries, reassignable channels, built-in MIDI support for remote dimming and scene triggering. Coordinate light shows to music using the direct audio input connector or built-in microphone. Stack scenes for simultaneous or sequential playback. <ul style="list-style-type: none"> • (16) Tri 24 LED outdoor-rated light fixtures, flicker-free operation • (16) Fixture Clamps • (16) Safety Cables • (7) Meter Power Extensions • (7) Meter Data Extensions • (1) 3-Pin DMX Cable 50' 	42015
6ft Truss Mount Light Bar	simplify theatrical light mounting with 2" OD x 72" pipe that accommodates standard light clamps. Pre mount and wire lights to pipe. Pipe attaches to canopy trusses and light bar. (lights not included)	40116

Pro-Sound System #1	includes: 12-Channel Mixing Console with 12 inputs with internal effects, 12 Input channels (6 Mics + 4 Stereo line inputs), 3 band EQ (Ch 1-7/8), 2 band EQ (Ch 9/10-11/12), 4 busses (Stereo + 2 groups), 1 Aux send + 1 Effect send, 1 Stereo Aux return, SPX Digital multi effects, XLR Connectors, (2) Powered Speakers with 225w amp driving 12" woofer & 75w amp driving 1.75" compression driver. 50hz - 20kHz frequency range, SPL if 121 db., (2) 50' speaker cables.(2) speaker stands with bag, (2)microphone stands w/Telescoping Boom (2) Shure microphones, (4) 50' Mic Cables	41110
Pro-Sound System #2	includes: 16-Channel Mixing Console with 16 input channels (10 Mics + 4 Stereo line inputs), 3 band Mid-sweep EQ (Ch 1-8), 3 band EQ (Ch 9/10-15/16), 6 busses (Stereo + 4 groups), 2 Aux sends + 1 Effect send, 1 Stereo Aux return, SPX Digital multi effect, XLR Connectors, (2) sound speakers with Bi-amplified 12" cone type woofer and 1.75" compression driver, total output power up to 400 watts (LF: 300 watts, HF: 100 watts burst.), input level range from -36 dB to +4 dB accepts mixer and microphone output, (2) speaker stands, (4) microphone stands, (4) hand microphones W/switch (6) 50' mic. cables	41111
Pro-Sound System #3	Includes: 24-Channel mixing console. 16 Mic Inputs with 48V Phantom Power and HPF per channel, 24 Line Inputs (16 mono and 4 stereo), 6 AUX Sends + 2 FX Sends,4 GROUP Buses + ST Bus, 2 Matrix out, 1 Mono out. (1) 3200 W power amplifier - independent sweepable high-pass and low-pass filters on each channel. (4) weatherized sound speakers with high-impact polypropylene enclosure. High sensitivity, 131 dB maximum SPL. Power handling: 600 W continuous, 2400 W peak (1) CD player with USB port on front panel for iPod and other devices. CD-R/RW disc playback compatibility. MP3 and WMA compatibility, (4) speaker stands, (2) microphone stands, (2) hand microphones W/switch (2) 25' speaker cables, (2) 50' speaker cables (2) 50' mic. cables	41112
Line Array Pro-Sound System #4	includes: 24-Channel mixing console. 16 Mic Inputs with 48V Phantom Power and HPF per channel, 24 Line Inputs (16 mono and 4 stereo), 6 AUX Sends + 2 FX Sends,4 GROUP Buses + ST Bus, 2 Matrix out, 1 Mono out. (1) 3200 W power amplifier - independent sweepable high-pass and low-pass filters on each channel. (4) weatherized sound speakers with high-impact polypropylene enclosure. High sensitivity, 131 dB maximum SPL. Power handling: 600 W continuous, 2400 W peak (1) CD player with USB port on front panel for iPod and other devices. CD-R/RW disc playback compatibility. MP3 and WMA compatibility, (4) speaker stands, (2) microphone stands, (2) hand microphones W/switch (2) 25' speaker cables, (2) 50' speaker cables (2) 50' mic. cables	41112
Telescoping Speaker Support Beam Package	telescoping speaker hanging beams cantilever hanging speakers off left and right side of roof canopy. Speaker support beams retract into canopy during stage transport and storage. 800 lb maximum speaker weight each side.	90957

Options

Video Options

9'x 12' Video Screen	electric/motorized screen for outdoor stage theater applications. Ceiling installation. Motor in-the-roller design for silent operation and easy access front case panel. Electric operation has preset adjustable limit switches to automatically stop the screen at the desired viewing level. Available in either 110 and 220 volt models. Includes standard control module level, 3-button switch with box and cover plate. Includes wireless remote with up to 50 ft. range. (1) Projector mounting hardware *(video projector not included.)	42010
-----------------------------	--	--------------

Outdoor Event Emergency Response Planning

Recent high-profile incidents at outdoor public events have altered the regulatory focus and scrutiny of such events, increasing the necessity for pro-active planning to deal with potential emergency situations which might arise.

Risk Assessment - look at the whole picture:

- Consider all who could be affected by a hazard — exhibitors, entertainers, vendors, attendees, and staff
- Institute controlling efforts to diminish identified risks
- Establish the response measures to be executed in case of an emergency
- Identify first- and second-wave emergency services to be contacted

Plan & Train - Typical Potential Risks

- Severe Weather
- Fire
- Accident on Grounds
- Personal Injury/First Aid (illness, injury, heat related, attack)

Compliance with newly revised standards for outdoor public events consists of two parts.

Part 1 – Code compliant, properly maintained facilities (staging, seating, etc) properly erected by trained crews, operated by knowledgeable, trained staff.

Part 2 – An established, written emergency plan, training for all members of your staff, and follow your plan with progressive monitoring and appropriate implementation.

Check with your insurer to determine that you have adequate coverage for the type and size event that you are planning, and that you have addressed any concerns that they may have.

Make sure that all outside contractors and vendors offering event services have insurance coverage.

Preliminary Planning

Staff/Security Meeting – Plan:

- Entrances/Exits
- Shelter Locations & Access
- Emergency Vehicle Access
- Emergency Equipment
- Communications – Staff Radios/Phones
- Communications - Public
- Weather Monitoring
- Public Address Equipment
- Public Relations – Designate Media Spokes-Person

Day(s) of Event

Staff/Security Meeting – brief:

- Copy of Emergency Plan for Each Member
- Identify Entrances/Exits
- Identify Emergency Shelter
- Identify Emergency Equipment Location(s)
 - Defibrillator
 - Fire Extinguisher
 - Cold Water/Ice
- Verify weather monitoring system
- Emergency Services Contacts
- Provide Copy of Emergency Plan to Each Vendor

Safety is First Priority

The following pages offer a sample template for establishing staff procedures for your event. Adjust the procedures and actions to meet the specific environment and activities of your event(s) and local public-safety agency requirements. This information and provided outline are intended to serve only as a guide, and are not offered as all inclusive. Consult your local requirements when preparing your plan.

Event Emergency Response

Event Date(s)	Start/End Times
----------------------	------------------------

<p>Weather _____</p> <ul style="list-style-type: none"> • Monitor Weather • Notify committee/vendors/ attendees of conditions • Detail severity & timeline of storm and related actions • Identify exits <table border="1" style="width: 100%; border-collapse: collapse; margin-top: 10px;"> <thead> <tr style="background-color: #ff0000; color: white;"> <th style="width: 30%; padding: 2px;">Wind Speed MPH</th> <th style="width: 70%; padding: 2px;">ACTION</th> </tr> </thead> <tbody> <tr> <td style="border: none;">_____</td> <td style="border: none;">Move Crowd Away From Stage</td> </tr> <tr> <td style="border: none;">_____</td> <td style="border: none;">Remove Banners</td> </tr> <tr> <td style="border: none;">_____</td> <td style="border: none;">Remove Speakers</td> </tr> <tr> <td style="border: none;">_____</td> <td style="border: none;">Lower Stage Canopy</td> </tr> <tr> <td style="border: none;">_____</td> <td style="border: none;">Direct Attendees to Exits</td> </tr> </tbody> </table> <ul style="list-style-type: none"> • Direct Attendees to Take Cover • Direct Attendees to Exits • Staff Go To Shelter <p>Accident _____</p> <ul style="list-style-type: none"> • Contact Appropriate Emergency Service(s) • Inform Staff & Security of Situation • Go to incident area • Clear crowd from area • Clear path for emergency equipment • Do not alarm attendees • Answer all questions honestly with limited detail – direct questions to designated PR member 	Wind Speed MPH	ACTION	_____	Move Crowd Away From Stage	_____	Remove Banners	_____	Remove Speakers	_____	Lower Stage Canopy	_____	Direct Attendees to Exits	<p>Fire _____</p> <ul style="list-style-type: none"> • Contact Fire and Police • Go to incident area • Clear crowd from area • Clear path for emergency equipment • Notify staff/vendors/attendees of condition <p>Monitor Situation</p> <ul style="list-style-type: none"> • Do not alarm attendees • Update staff and security • Answer all questions honestly with limited detail – direct questions to designated PR member <p>Personal Injury _____</p> <ul style="list-style-type: none"> • Contact Appropriate Emergency Service(s) • Inform staff and security • Go to incident area • Clear crowd from area • Clear path for emergency equipment if appropriate • Do not alarm attendees • Update staff and security • Answer all questions honestly with limited detail – direct questions to designated PR member
Wind Speed MPH	ACTION												
_____	Move Crowd Away From Stage												
_____	Remove Banners												
_____	Remove Speakers												
_____	Lower Stage Canopy												
_____	Direct Attendees to Exits												

Emergency Contact Phone Numbers	AGENCY	NUMBER
	Police	
	Fire	
	EMS	
	Event Coordinator	
	Media Relations	

DOT Trailer Lighting

All trailer body lights, which include marker lights, turn signals, and brake lights, should be inspected frequently for proper operation.

Always connect 12V trailer connector to towing vehicle before towing. Check and verify correct light operation.

Regular Inspections

Each Trip	Trailer Marker and Signal Lights Electric Brake Operation Tire, Wheel and Suspension Conditions Loading Hydraulic Hose Condition Coupler/Hitch Condition Hitch Pins and Retainers Trailer Connection
Monthly	Hydraulic Fluid Level Battery Condition Spring Hanger and Suspension Bolts
Yearly	Hinge Lubrication Wheel Bearings Brake Condition Jack Gear Lubrication Coupler Lubrication

Section 7

Maintenance & Service

Maintenance

The following maintenance section is provided to help you maintain maximum dependability and maximum life from your Century Stage.

Consumable and high wear components such as tires, brakes, bearing, light bulbs, hydraulic fluid, batteries, electric system components, and hydraulic system components, are selected to be locally available through most automotive or industrial supply houses. Needed parts can therefore be quickly obtained.

For additional part or service information, please call Century Customer Service at 800/248-3371, or 812/246-3371.

Hydraulic System

For ease of inspection and service, the hydraulic pump, hydraulic fluid reservoir, (battery, and battery charger on powered units only) have been grouped in a locking compartment located inside the frame of the stage. Periodically check to see that the hydraulic fluid reservoir is full with approximately an inch gap from the top when stage is **Open**.

Reservoir is mounted in the mechanical compartment. Should additional fluid be needed, add only good quality, heavy-duty hydraulic fluid.

When the hydraulic cylinders are under load for long periods of time, a small amount of fluid leakage from the cylinder should be considered normal.

Changing/flushing hydraulic fluid is not necessary unless fluid looks discolored or dirty. If stage is being used multiple times daily, consider changing/flushing hydraulic fluid every five years.



CAUTION: DO NOT ATTEMPT TO OPERATE STAGE WITHOUT HYDRAULIC OIL UNDER ANY CONDITION.

Hydraulic Pump Service Starting Procedure

Fill the reservoir with Multi Guard Hydraulic **AW32** to an inch from the top when the stage is fully **open**. It is essential that the oil be kept very clean. Any dirt or lint introduced into the reservoir will eventually cause trouble.

Motor rotation must be as indicated by arrow decal on top of motor. In the event that the decal has been removed, motor rotation is counter-clockwise viewing from motor end. The wiring diagram is provided on the motor tag. When starting the motor for the first time, apply short durations of power to check rotation and flow from the pump. If flow does not start immediately, it may be due to wrong motor rotation.

Be sure to bleed all air from the system components since this will cause erratic operation.

- **Recommended Hydraulic Fluid** - Multi Guard Hydraulic **AW32** with anti-wear, rust and oxidation inhibitors.

LIMITED WARRANTY AND REMEDY: Century warrants to the original Purchaser that those products manufactured by Century and used in the manner for which they are intended shall be free from defects in materials and workmanship a period of (3) years after delivery. Notwithstanding the foregoing, purchaser is responsible for return shipping for service. Items manufactured by others are subject to their respective manufacturer's warranty, if any. **Century does make any other representations or warranties, express or implied, and disclaims all other warranties including, but limited to, any implied warranty of merchantability and warranty of fitness for a particular purpose.** Purchaser agrees that Century is not liable for incidental, consequential, or special damages of any kind.

EXCLUSIVE VENUE/ APPLICABLE LAW: Purchaser agrees to the exclusive venue and jurisdiction of the State and Federal Courts located in Clark County, Indiana for any action involving this Agreement or the goods which are the subject matter of the same. This Agreement shall be construed according to the laws of the State of Indiana. **The parties hereto each knowingly and voluntarily agree to waive any right to a trial by jury with respect to any action involving this Agreement or its subject matter, including without limitation any manufactured goods.**

***TERMS:**

Net 30 Days

Approximate production lead time 90-120 days ARO

Price Does Not include any applicable Federal, State or local taxes

Price quote good 90 days

PURCHASER AGREES that a 1 ½% per month service charge or the maximum legal rate, whichever is less, shall be added to unpaid invoices from the due date thereof, plus reasonable collection and attorneys' fees if placed for collection. Upon default by Purchaser, Century shall be entitled to retain any Deposit and enforce all remedies available to it as a seller under I.C. 26-1-2-703. Purchaser acknowledges that the goods manufactured by Century constitute specially manufactured goods and are not suitable for sale to others in the ordinary course of business. Purchaser agrees to maintain these goods in a safe condition and to operate the same in a safe manner. Purchaser agrees to indemnify and hold harmless Century and its officers, directors, employees, agents or subcontractors from and against any and all claims, demands and causes of action asserted by any other person or entity, and all resulting damages, liabilities, costs, losses and expenses of any kind (including reasonable attorney's fees), arising directly or indirectly from any acts by the purchaser or any of its employees, agents, or customers in connection with the purchase, ownership or use of the subject matter of this Agreement. All estimates for production time are estimates only and Century makes no warranty or representation concerning production times. Purchaser agrees receipt and use of manufactured product(s) constitute agreement to these terms. This represents the entire agreement of the parties; any changes, amendments, modifications, additions or alterations made by Purchaser without the express written acceptance of Century are rejected.